

CyberPower[®]

User's Manual

OLS3S15KE(XL)

OLS3S20KE(XL)

CyberPower Systems Inc.

www.cyberpower.com

K01-C000121-02

CONTENT :

1. Safety	1
1.1. Installation	1
1.2. Operation	1
1.3. Maintenance, Servicing and Faults	2
1.4. Transport.....	3
1.5. Storage	3
1.6. Standards.....	3
2. Description of Commonly Used Symbols	4
3. Introduction	4
3.1. Feature.....	5
3.2. Product Specification and Performance	6
3.3. Operating Environment	8
4. Installation	9
4.1. Tools	9
4.2. Unpacking	9
4.3. Contains:.....	10
4.4. Electrical Installation	11
4.5. Internal Battery Pack Connecting Procedure of OLS3S15KE/20KE	14
4.6. External Battery Pack Connecting Procedure	15
4.7. EPO Connection	16
4.8. Backfeed Protection	16
5. Operation	17
5.1. Display Panel	17
5.2. Turning On and Turning Off UPS	19
5.3. LCD Operation	20
6. Special Function	25
6.1. ECO Function.....	25
6.2. Converter Function.....	26
6.3. Parallel Function	26
7. Trouble Shooting	30
7.1. Trouble Shooting According to Warning Indication	30
7.2. Trouble Shooting According to Fault Indication.....	32
7.3. Trouble Shooting in Else Cases	33

- 8. Battery Maintenance34**
 - 8.1. Replacement and Disposal of Batteries 34
 - 8.2. Easy for Battery Replacement.....35
- 9. Communication Port.....37**
 - 9.1. USB Interface.....37
 - 9.2. Dry contact Interface(optional)37
 - 9.3. RS232 Interface37
 - 9.4. Intelligent slot37

1. Safety

Please read carefully the following user manual and the safety instructions before installing the unit or using the unit!

1.1. Installation

- This is permanently connected equipment, and it must be installed by qualified maintenance personnel.
- Condensation may occur if the UPS is moved directly from a cold to a warm environment. The UPS must be absolutely dry before being installed. Please allow an acclimatization time of at least two hours.
- Do not install the UPS near water or in damp environment.
- Do not install the UPS where it would be exposed to direct sunlight or near heat.
- Do not block ventilation openings in the UPS's housing.
- Do not connect appliances or items of equipment which would overload the UPS (e.g. laser printers, etc.) to the UPS output.
- Place cables in such a way that no one can step on or trip over them.
- UPS has provided earthed terminal, in the final installed system configuration, equipotential earth bonding to the external UPS battery cabinets.
- An integral single emergency switching device which prevents further supply to the load by the UPS in any mode of operation should be provided in the building wiring installation.
- An appropriate disconnect device as short-circuit backup protection should be provided in the building wiring installation.
- For three-phase equipment connection to an IT power system, a four-pole device which can disconnect all phase conductors and the neutral conductor should be provided in the building wiring installation.
- This is permanently connected equipment, it must be installed by qualified maintenance personnel.
- Earth connection essential before connecting to the building wiring terminal.

1.2. Operation

- Do not disconnect the earth conductor cable on the UPS or the building wiring terminals in any time since this would cancel the protective earthing of the UPS system and of all connected loads.

- The UPS output terminal block may be electrically live even if the UPS system is not connected to the building wiring terminal, for there is internal current source (batteries).
- In order to fully disconnect the UPS, turn the Main1/Main2/N input breaker in the "OFF" position, then disconnect the mains lead.
- Ensure that no liquid or other foreign objects can enter the UPS.

1.3. Maintenance, Servicing and Faults

- The UPS operates with hazardous voltages. Repairs should be carried out only by qualified maintenance personnel.
- **Caution** - risk of electric shock. Even after the unit is disconnected from the mains power supply (building wiring terminal), components inside the UPS are still connected to the battery which are potentially dangerous.
- Before carrying out any kind of service and/or maintenance, please disconnect the batteries. Verify that no current is present and no hazardous voltage exists in the capacitor or BUS capacitor terminals.
- Batteries must be replaced only by qualified personnel.
- **Caution** - risk of electric shock. The battery circuit is not isolated from the input voltage. Hazardous voltages may occur between the battery terminals and the ground. Verify that no voltage is present before servicing!
- Batteries have a high short-circuit current and pose a risk of shock. Take all precautionary measures specified below and any other measures necessary when working with batteries:
 - remove all jewellery, wristwatches, rings and other metal objects
 - use only tools with insulated grips and handles.
- When changing batteries, replace with the same quantity and the same type of batteries.
- Do not attempt to dispose of batteries by burning them. It could cause explosion.
- Do not open or destroy batteries. Effluent electrolyte can cause injury to the skin and eyes. It may be toxic.
- Please replace the fuse only by a fuse of the same type and of the same amperage in order to avoid fire hazards.
- Do not dismantle the UPS, except the qualified maintenance personnel.

1.4. Transport

Please transport the UPS only in the original packaging to protect against shock and impact.

1.5. Storage









The UPS must be stockpiled in the room where is ventilated and dry.

1.6. Standards

* Safety	
IEC/EN 62040-1	
* EMI	
Conducted Emission.....:IEC/EN 62040-2	Category C3
Radiated Emission.....:IEC/EN 62040-2	Category C3
*EMS	
ESD.....:IEC/EN 61000-4-2	Level 3
RS.....:IEC/EN 61000-4-3	Level 3
EFT.....:IEC/EN 61000-4-4	Level 4
SURGE.....:IEC/EN 61000-4-5	Level 4
Low Frequency Signals.....:IEC/EN 61000-2-2	
Warning: This is a product for commercial and industrial application in the second environment-installation restrictions or additional measures may be needed to prevent disturbances.	

2. Description of Commonly Used Symbols

Some or all of the following symbols may be used in this manual. It is advisable to familiarize yourself with them and understand their meaning:

Symbol and Explanation			
Symbol	Explanation	Symbol	Explanation
	Alert you to pay special attention		Caution of high voltage
	Alternating current source(AC)		Direct current source(DC)
	Turn on or turn off the UPS		Protective ground
	Recycle		Do not dispose with ordinary trash

3. Introduction

This Online Series is an uninterruptible power supply incorporating double-conversion technology. It provides perfect protection specifically for computer equipment, communication systems to computerized instruments.

It's true online double-conversion design eliminates all mains power disturbances. A rectifier converts the alternating current from the utility power to direct current. This direct current powers the inverter. On the basis of this DC voltage, the inverter generates a pure sinusoidal AC voltage, which is constantly powering the loads.

Computers and Peripherals are thus powered entirely by the UPS. In the event of power failure, the maintenance-free batteries power the inverter.

This manual covers the UPS listed as follows. Please confirm whether it is the model you intend to purchase by performing a visual inspection of the Model No. on the rear panel of the UPS.

Model NO.	Type	Model NO.	Type
OLS3S15KE	Standard	OLS3S15KEXL	Extended backup time
OLS3S20KE		OLS3S20KEXL	

"XL" Model: Extended backup time.

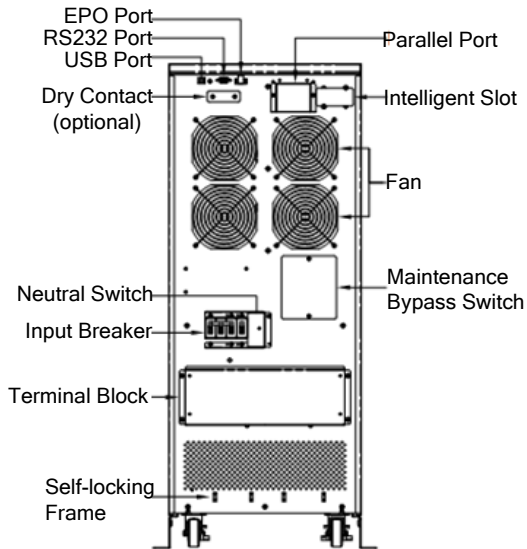

Fig.3-1 The rear view OLS3S15KE(XL)/OLS3S20KE(XL)

3.1. Feature

The tower 3-phase series UPS providing outstanding performance and reliability, the UPS's unique benefits include:

- True online double-conversion technology with high power density, utility frequency independence, and generator compatibility.
- True three-phase power factor correction and high input power factor ($PF \geq 0.99$). Save the installation cost and reduce the pollution back feed into upstream power system.
- Online UPS design with pure sine wave output.
- High output power factor (0.9), to adapt more type load.
- Overall high efficiency > 94%, saving the operating cost.
- Intelligent Battery Management technology that uses advanced battery

management to increase battery service life, optimize recharge time.

- Selectable High ECO mode or Converter mode operation.
- Start-on-battery capability for powering up the UPS even if utility power is not available.
- Standard communication options: one RS232 communication port, one USB communication port.
- Optional connectivity cards with enhanced communication capabilities.
- Shutdown control through the EPO port.
- Maintenances are simplified by allowing the safe replacement of batteries without powering down the UPS.
- N+X parallel redundancy to increase the reliability and flexibility. The max parallel number is 4.
- User-friendly LCD display and LED indicators.
- Easily battery exchange or extension and available to extend the backup time.

3.2. Product Specification and Performance

General Specification

Model		OLS3S15KE(XL)	OLS3S20KE(XL)
Power Rating		15kVA/13.5kW	20kVA/18kW
Input	Voltage Range	110~276Vac(Depends on load level)	
	Rated Current	L1/L2/L3 : 25(28)A	L1/L2/L3 : 33(36)A
Battery	Rated Voltage	240Vdc	
	Rated Current	69A	82A
Output	Wave Form	Sine	
	Voltage*	208/220/230/240Vac	
	Current	64.9/68.1/65.2/62.5A	86.5A/90.9A/87.0A/83.3A
Dimension(W×D×H)		350×650×890mm	
Net Weight		172 (59)kg	

*The load capacity would be derated to 90% automatically when the output voltage is adjusted to 208Vac.

Electrical Performance

Input			
Model	Phase	Frequency Range	Power Factor
OLS3S15KE(XL) /OLS3S20KE(XL)	Three-phase	(45~55)/(54~66)Hz	≥0.99 @ full load
Output			
Voltage Regulation	± 1%		
Load Type	0.9 lag		
Frequency	Synchronized 50/60Hz ± 10% @Line mode ± 0.1% of normal frequency @Battery mode		
THDV	THD<2% Full load (Linear Load) THD<5% for reference non-linear load		
Overload*	Line model: 5 minutes 100%~110%; 1 minute 110%~130%; 10 seconds 130~150%; 2 seconds ≥150%. Battery model: 1 minutes 100%~110%; 10 seconds 110%~130%; 2 seconds ≥130%.		

*The overload capacity would be derated automatically while the circumstance temperature is larger than 35 degree.

3.3. Operating Environment

Temperature	Humidity	Altitude	Storage temperature
0°C~40°C	<95%	<1000m	-15°C~50°C

Note: if the UPS is installed or used in a place where the altitude is above than 1000m, the output power must be derated in use, please refer to the following:

Altitude (M)	1000	1500	2000	2500	3000	3500	4000	4500	5000
Maximum Power	100%	95%	91%	86%	82%	78%	74%	70%	67%

4. Installation





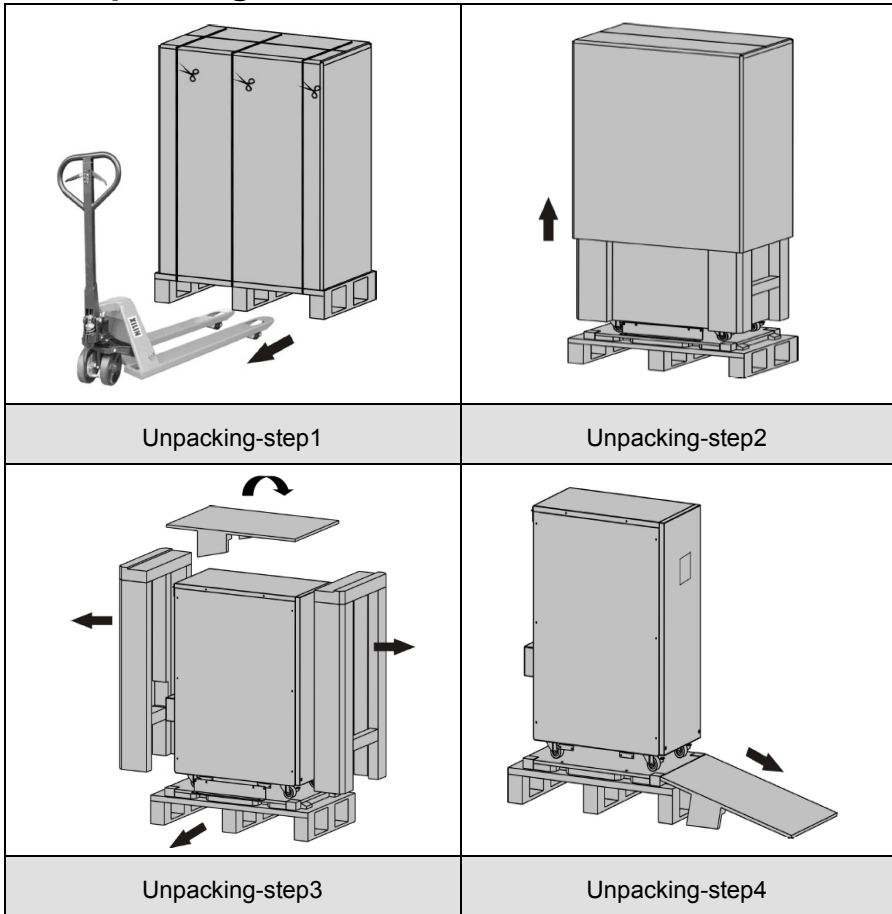

4.1. Tools

Tools Kit			
	Lifter		Phillips screwdriver
	Scissors		Wrench

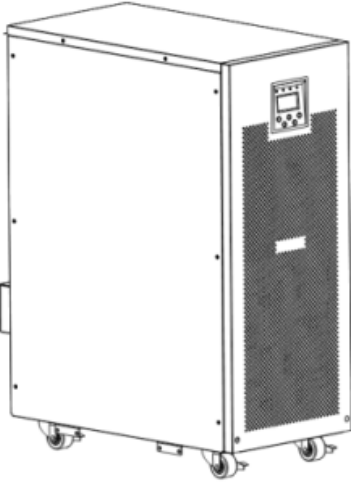
4.2. Unpacking

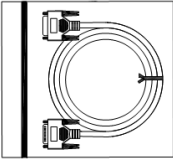

4.3. Contains:

			
		<p>User's Manual</p>	
			
<p>UPS</p>		<p>Parallel Cable</p>	
			
<p>USB Cable</p>	<p>RS232 Cable (optional)</p>	<p>Parallel Cable</p>	<p>Terminal</p>

***PowerPanel® Business Edition software is available on our website. Please visit www.cyberpower.com and go to the Software Section for free download.**

CAUTION! Inspect the appearance of the UPS to see if there is any damage during transportation. Do not turn on the unit and notify the carrier and dealer immediately if there is any damage or lacking of some parts.

4.4. Electrical Installation

4.4.1. Notes for installation

- The UPS must be installed in a location with good ventilation, far away from water, inflammable gas and corrosive agents.
- Ensure the air vents on the front and rear of the UPS are not blocked. Allow at least 0.5m of space on each side.
- Condensation to water drops may occur if the UPS is unpacked in a very low temperature environment. In this case it is necessary to wait until the UPS is fully dried inside out before proceeding installation and use. Otherwise there are hazards of electric shock.
- Once the installation is completed, the side mounting brackets (used in shipping) shall be fixed back to ensure the stability of the UPS enclosure. If impossible, additional stability can be added by anchoring the mounting brackets to the floor with M8 bolts. See Fig.4-1.

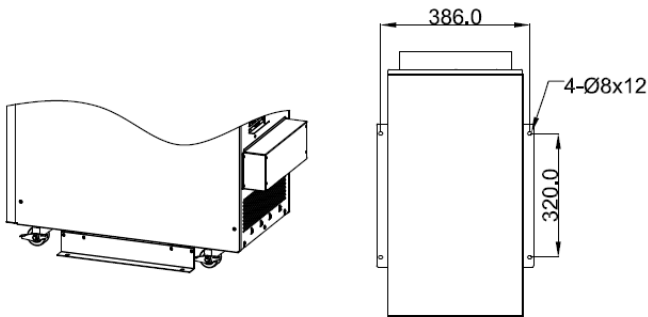

Fig.4-1 Additional stability

4.4.2. Power Wires Installation

Installation and wiring must be performed in accordance with the local electric code and the following instructions by professional personnel.

For safety, please cut off the mains power switch before installation

- 1) Open the terminal block cover located on the rear panel of the UPS. Please refer to the appearance diagram.
- 2) It is recommended to select the UL1015 6AWG(25mm²) wire or other insulated wire which complies with AWG Standard for the UPS input and output wirings.

Use cable cross section and protective device specification :

Model	OLS3S15KE(XL)/OLS3S20KE(XL)
Input Main1 L1,L2,L3 Min.conductor cross section Max.conductor cross section	6mm ² (UL1015 8AWG) 10mm ²
Input Main1 breaker	60A,250Vac
Input N, Main2 Min.conductor cross section Max.conductor cross section	21mm ² (UL1015 6AWG) 25mm ²
Input Main2 breaker	100A,250Vac
Input fuse	50A,690Vac
Output L,N, Min.conductor cross section Max.conductor cross section	21mm ² (UL1015 6AWG) 25mm ²
External Battery Cabinet Positive Pole(+), Negative pole(-), Min.conductor cross section Max.conductor cross section	21mm ² (UL1015 6AWG) 25mm ²
Line input Backfeed protection device	A 4-pole disconnection device with 100A/250Vac, less than 15s break time and min. 1.4mm clearance will be used in final installation for backfeed protection in line input.
Main2 input Backfeed protection device	A 2-pole disconnection device with 100A/250Vac, less than 15s break time and min. 1.4mm clearance will be used in final installation for backfeed protection in line input.
Protective Earthing conductor	Max.25mm ² (UL1015 6AWG)

Note: Do not use the wall receptacle as the input power source for the UPS, as its rated current is less than the UPS's maximum input current. Otherwise the receptacle may be burned and destroyed.

3) Connect the input and output wires to the corresponding input and output terminals according to the following diagram.

Note: Make sure that the input and output wires and the input and output terminals are connected tightly.

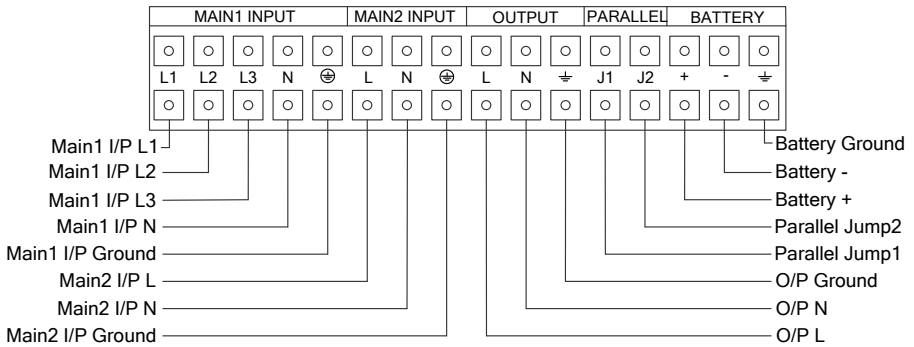

Fig.4-2 Input and output Terminal Block wiring diagram

Important notes:

If the UPS is used in single mode, J1 and J2 must be connected.

If the UPS is used in parallel mode, the Jumper between J1 and J2 must be removed.

- 4) The protective earth ground wire refers to the wire connection between the equipment which consumes electric equipment and the ground wire. The wire diameter of protective earth ground wire should be at least as above mentioned for each model and green wire or green wire with yellow ribbon wire is used.
- 5) After having completed the installation, make sure the wiring is correct.
- 6) Please install the output breaker between the output terminal and the load, and the breaker should with leakage current protective function if necessary.
- 7) To connect the load with the UPS, please turn off all the loads first, then perform the connection and finally turn on the loads one by one.
- 8) No matter the UPS is connected to the utility power or not, the output of the UPS

may have electricity. The parts inside the unit may still have hazardous voltage after turning off the UPS. To make the UPS have no output, power off the UPS, and then disconnect the utility power supply.

- 9) Suggest charging the batteries for 8 hours before use. After connection, turn the M1/M2/N input breaker in the "ON" position, the UPS will charge the batteries automatically. You can also use the UPS immediately without charging, but the backup time may be less than the standard value.
- 10) If it is necessary to connect the inductance load such as a monitor or a laser printer to the UPS, the start-up power should be used for calculating the capacity of UPS, as its start-up power consumption is too big when it is started.

4.5. Internal Battery Pack Connecting Procedure of OLS3S15KE/20KE

- 1) Loosen the screws to remove the front panel and disconnect the connector on the LCD display board.

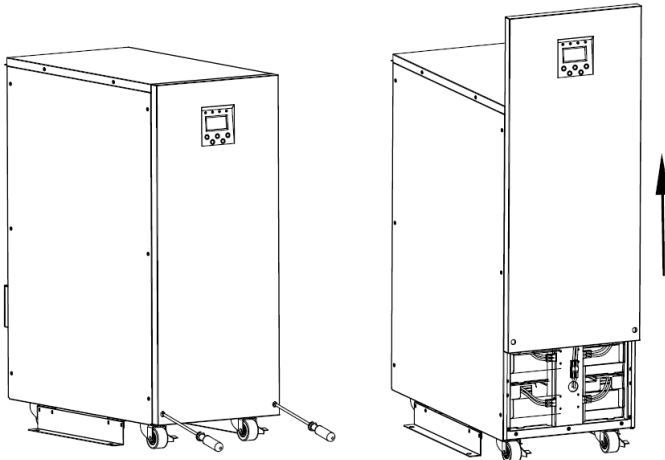

Fig.4-3 Remove Front Panel

- 2) Connect internal battery plug and socket (red with red and black with black). Then connect the connector on the LCD display board and retighten the front panel. See Fig.4-4.

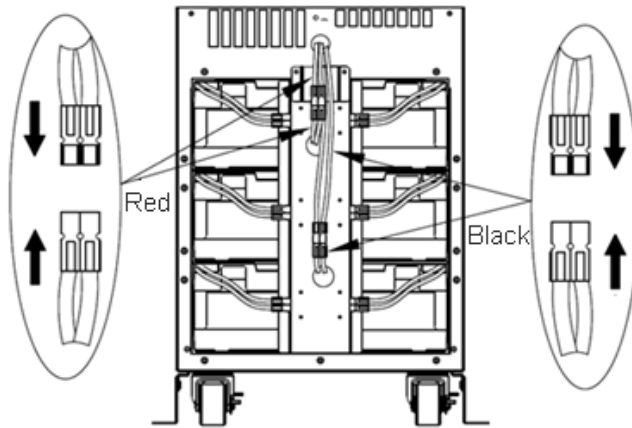

Fig.4-4 Connect the internal Battery Pack DC connectors

4.6. External Battery Pack Connecting Procedure

- 1) The nominal DC voltage of external battery pack is 240Vdc. To achieve longer backup time, it is possible to connect multi-battery packs, but the principle of "same voltage, same type" should be strictly followed.
- 2) Select the UL1015 6AWG (25mm²) wire or other insulated wire which complies with AWG Standard for the UPS battery wirings. The procedure of installing battery bank should be complied with strictly. Otherwise you may encounter the hazardous of electric shock.
 - If the UPS (OLS3S15KE/OLS3S20KE) has internal battery pack, first of all, disconnect the internal battery pack DC connectors. Please refer to the chapter 4.5.
 - A DC breaker must be connected between the external battery pack and the UPS. The capacity of breaker must be not less than the data specified in the general specification.
 - Set the external battery pack breaker in "OFF" position and connect the batteries.
 - Connect the external battery pack to the battery terminals.
 - Reconnect the internal battery pack DC connectors, if you had did step one.
- 3) Do not attempt to connect any loads to the UPS now. Connect the input power wire to the right position first. And then set breaker of the battery pack in the "ON" position. Setting the input breaker in the "ON" position. The UPS begins to charge the battery packs at the time.

4.7. EPO Connection

EPO (Emergency power off): when the emergency occurs, such as the failure of load, the UPS can cut off the output at once by operating the EPO port manually.

The connection:

Normally the EPO connector is closed with a wire on the rear panel (Fig.4-6), which is supplied in the accessory. Once the connector is open, the UPS would stop the output and enter EPO status (Fig.4-5).

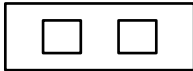

Fig.4-5 Enable the EPO status

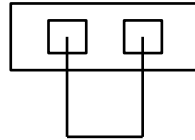

Fig.4-6 Disable the EPO status

To recover to normal status, first EPO connector should be closed, and enter LCD menu (illustrated in the chapter of 5.3) to clear EPO status, then UPS would stop alarm and recover to Bypass model. And UPS needs be turned on by manual operation.

4.8. Backfeed Protection

On customers side an additional external isolation device (magnetic contactor, MC or minimum voltage tripping device) must be provided as shown in the following diagram. The isolation device must be able to carry the UPS input current (see resp. table of basic UPS operating instructions).

The isolation device has to be installed in the bypass source path.

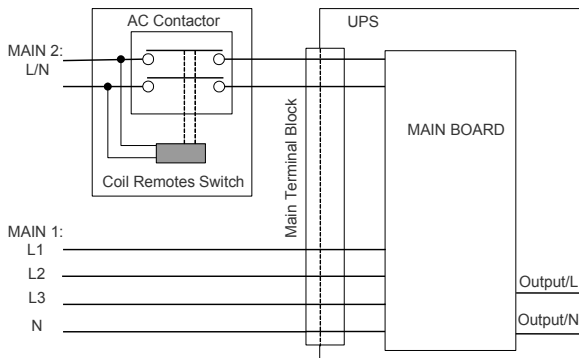

Fig.4-7 Typical external isolating device installation

5. Operation

5.1. Display Panel

The UPS has a five-button, dot matrix LCD with white text and a blue background. Besides the LCD, the UPS has four colorized LED to provide more convenient information.

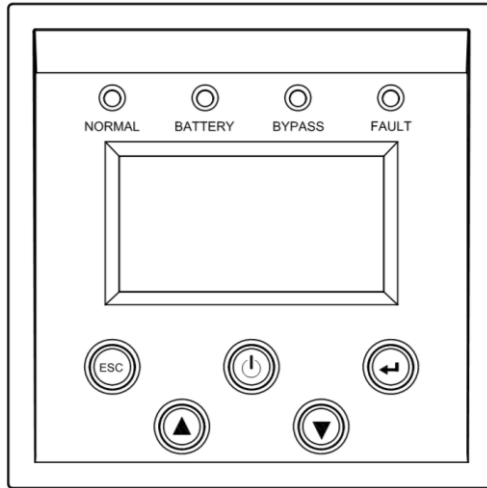





Fig.5-1 LCD Panel

Control button functions:

The Button	Function	illustration
	Power on	When the unit is no power and has connected with battery, press this button more than 200ms to power on
	Turn on	When the unit is powered on and is in Bypass mode, press this button more than 1s to turn on
	Turn off	When the unit has been turned on, press this button more than 3s to turn off
	Enter	Press this button more than 200ms to confirm current selection or enter the current selection window
ESC	Exit	Press this button more than 200ms to cancel current selection and return to previous menu

	UP	Press this button more than 200ms to move the focus to the up menu
	Down	Press this button for more than 200ms to move the focus to the down menu

LED definition:

UPS State	Normal (Green LED)	Battery (Yellow LED)	Bypass (Yellow LED)	Fault (Red LED)
Bypass mode with no output			★	□
Bypass mode with output			○	□
Line mode	○			□
Battery mode	○	○		□
ECO mode	○		○	□
Battery test mode	※	※	※	※
Turn on	※	※	※	※
Fault mode			□	○
Warning mode	□	□	□	★

Note:

○: Lightened constantly; ※: #1-#4 Lightened circularly

★: Flashing; □: Depended on the fault/warning status or other status

Alarm definition:

UPS Condition	Buzzer Status
Fault active	Continuous
Warning active	Beep every second
Battery mode	Beep every 4 seconds, if battery low, buzzer Beep every second
Bypass mode	Beep every 2 minutes
Overload	Beep twice every second

The UPS provides useful information about UPS itself, load status, battery, events,

identification, and settings through the front panel display.

During powering on, the LCD would display the CyberPower logo for several seconds and then enter to the default page which shows the UPS status summary.

On the UPS status screen it provides the following information:

- Status summary, including mode, load, battery and utility
- Alarm status, if any is present.
- Fault status, if any is present.
- Output parameter, including output voltage, current and frequency.
- Input parameter, including input voltage and frequency.
- Bypass parameter, including bypass voltage and frequency.
- Power parameter, including output VA and watt.
- Battery parameter, including battery capacity, voltage and remain time.

5.2. Turning On and Turning Off UPS

Attention: The UPS could only be turning on while connecting with the mains at the first time.

Attention: Please switch off the connected loads first before turning on the UPS, and switch on the loads one by one after the UPS is turned on. Switch off all of the connected loads before turning off the UPS.

Turning on UPS with mains:

- 1) Check all the connection is correct. Check the breaker of external battery pack is in "ON" position.
- 2) Set input breaker in "ON" position. At this time the fan begins to rotate, LCD will show "CyberPower". Then LCD will show the default UPS status summary screen after UPS finishing self-test.
- 3) By pressing button  continuously for more than 1 second, the buzzer will beep for 1s, UPS starts to turn on.
- 4) A few seconds later, the UPS turns into Line mode. If the mains power is abnormal, the UPS will transfer to Battery mode without output interruption of the UPS.

Turning on UPS without mains:

- 1) Check all the connection is correct. Check the breaker of external battery pack is in "ON" position.
- 2) By pressing button  continuously for more than 200ms, the UPS would be powered on. At this time the fan begins to rotate, LCD will show "CyberPower".

Then LCD will show the default UPS status summary screen after UPS finishing self-test.

- 3) By pressing button  continuously for more than 1 second, the buzzer will beep for 1s, UPS starts to turn on.
- 4) A few seconds later, the UPS turns into Battery mode. If the mains power comes back, the UPS will transfer to Line mode without output interruption of the UPS.

Turning off UPS with mains:

- 1) To turn off the inverter of UPS by pressing button  continuously for more than 3s and the buzzer will beep for 3s. The UPS will turn into Bypass mode at once.
- 2) When completing the above action, UPS output voltage is still present. In order to cut off the UPS output, simply cut off the mains power supply. A few seconds later, LCD display shuts down and no output voltage is available from the UPS output terminal.



Turning off UPS without mains:



- 1) To power off the UPS by pressing button  continuously for more than 3s, and the buzzer will beep 3s. The UPS will cut off the output at once.
- 2) A few seconds later, LCD shuts down and no voltage is available from the UPS output.



5.3. LCD Operation

Except the default UPS status summary screen, the user could get more useful information about UPS current status, old events which ever occurred, UPS own identification, and could change the settings to fit the user own requirements, optimize the function of UPS.

The status screen:

In the UPS status screen, when pressing  or  >200ms the detailed information about UPS information that include alarm, fault output, input, bypass, load and battery parameter would be shown. See Fig.5-2.

when pressing  > 200ms the main menu would be shown. In fault or alarm screen, when pressing  > 200ms, the other alarm or fault would be shown by pressing

 or  >200ms, and press  >200ms the display would return to status screen. The main menu includes four branches: UPS control menu, setting menu,

event menu and identification menu. See Fig.5-3.

The control menu:

By pressing  on the menu of "Control", the display would enter the next control menu screen.

- 1) Buzzer mute
- 2) Battery test: is one command to control all UPS in a parallel system to do the battery test at the same time.
- 3) Clear EPO status: once EPO status is enabled, the UPS output would be cut off. To recover to normal status, first EPO connector should be closed, and enter this menu to clear EPO status, then UPS would stop alarm and recover to Bypass model. And UPS needs be turned on by manual operation.
- 4) Single UPS off: is one command to turn off one UPS which is operated currently in a parallel system and other UPS continue working to supply the load in the parallel system.

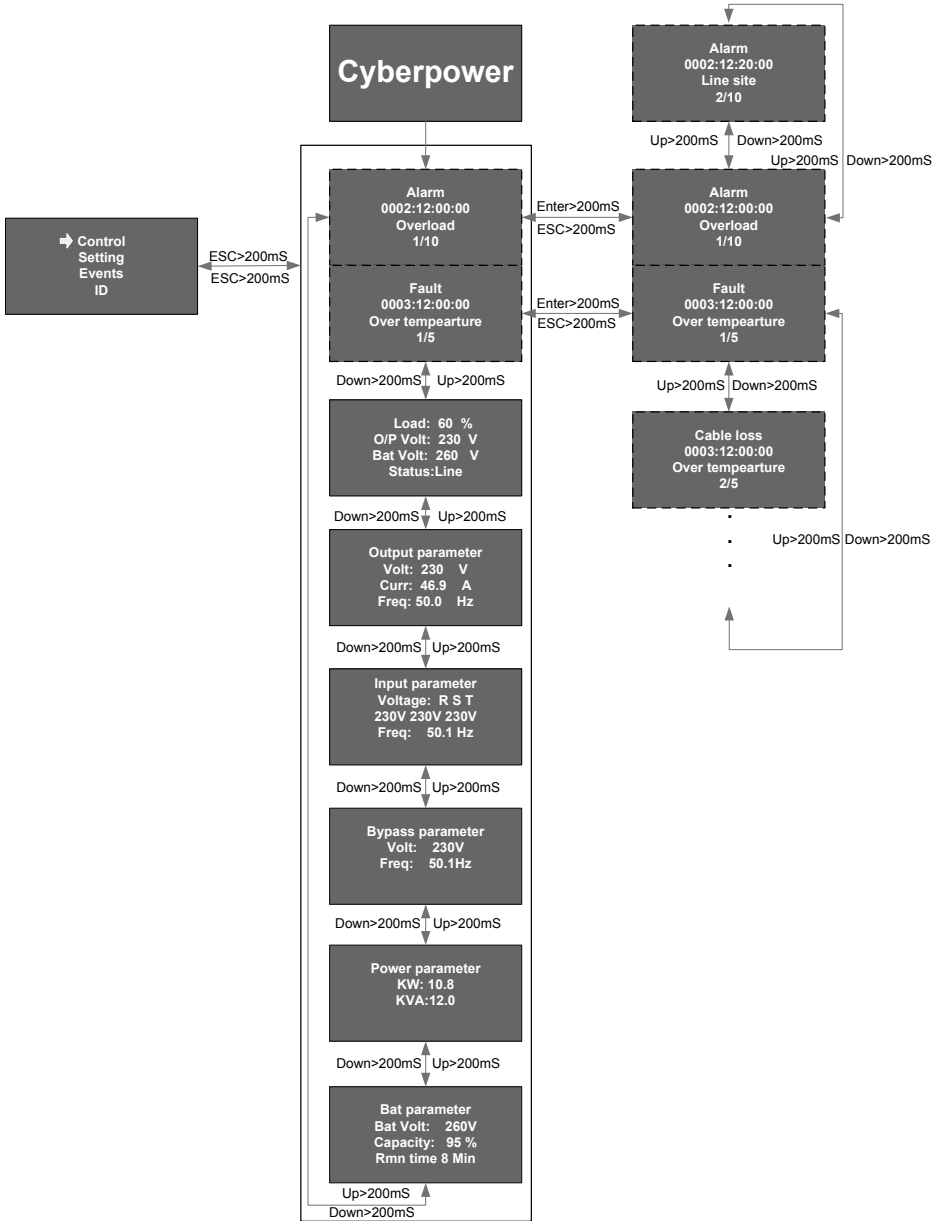

Fig.5-2 UPS status menu

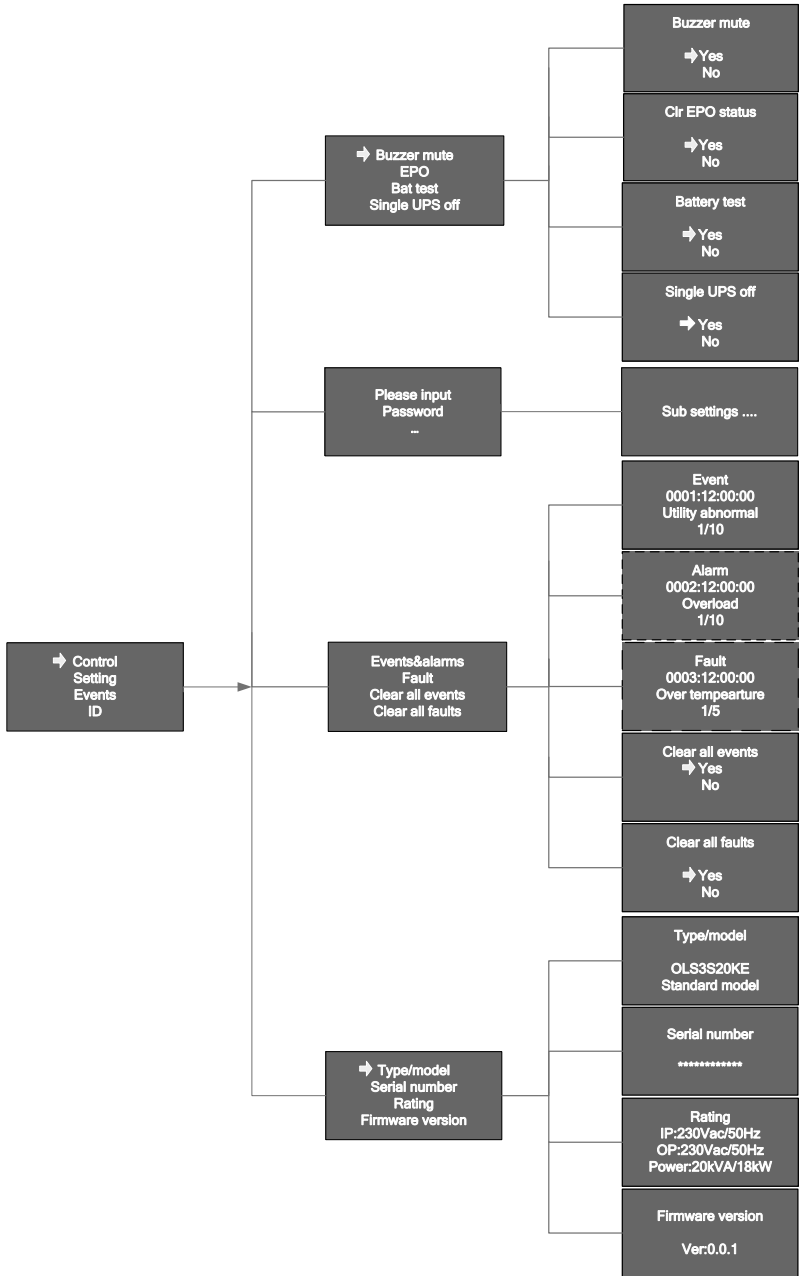

Fig.5-3 Main menu

The setting menu:

Please contact your local distributor for further information before using the settings. Some settings would change the specification, and some settings would enable or disable some functions. The unsuitable option set by user may result in potential failures or protecting function loss, even directly damage the load, battery or UPS. The most of settings could only be done while UPS is in Bypass mode.

Submenu Item	Optional Values		Default Value	
User password*	enabled/disabled		enabled	
Audio alarm	enabled/disabled		enabled	
DC start	enabled/disabled		enabled	
Auto Restart	enabled/disabled		enabled	
Automatic overload restart	enabled/disabled		enabled	
Auto Bypass	enabled/disabled		enabled	
Shorted restart	enabled/disabled		disabled	
Power strategy**	Normal/ECO/Converter		Normal	
Rated output voltage	208/220/230/240V		230V	
Output frequency	50/60Hz		50Hz	
Bypass voltage low range	10%,15%,20%		15%	
Bypass voltage high range	10%,15%		10%	
Bypass frequency range	1%~10%		10%	
ECO voltage range	10%,15%		10%	
ECO frequency range	1%~10%		5%	
Ext. Bat Type	Standard/Customized		Standard	
Ext. Bat String	0~15	1~15(XL)	0	1(XL)
Automatic battery tests period	0~45days		7days	

Set running time	Day: hour: minute: second 0000:0000:00~9999:23:59:59	Running time
Restore default setting***	Yes/NO	

*Password is AAAA when enabled.

**Read the chapter of 6.1 and 6.2, before using ECO or Converter function. UPS need shut down, if change work mode from converter to others.

***UPS need shut down.

6. Special Function

The series UPS has some special functions, which could satisfy some special application of user. And the functions have own features, please contact your local distributor for further information before using the function.

6.1. ECO Function

Brief introduction of ECO function:

If ECO function is set to enable, after the UPS is turned on, the power used by the load is directly supplied from the mains power via internal filter while the utility power is in normal range, so the economy mode could be gained in ECO mode. Once the mains power is loss or abnormal, the UPS would transfer to Line mode or Battery mode and the load is supplied continuously.

The great virtue is overall high efficiency \geq 97% of UPS, to save power for user.

But the disadvantage is:

- 1) The load can't be protected as well as in Line mode, for the load is directly supplied from the mains;
- 2) The transfer time of UPS output from ECO mode to Battery mode is about 10ms.

So the function is not suitable to some sensitive loads, and the region where the mains power is unstable.

Set the function:

The function could be enabled through the LCD setting in Bypass mode. Enter the power strategy setting menu by following chapter of 5.3.

6.2. Converter Function

Brief introduction of Converter function:

In converter mode, the UPS would free run with fixed output frequency (50Hz or 60Hz). Once the mains power is loss or abnormal, the UPS would transfer to Battery mode and the load is supplied continuously.

The great virtue is the output frequency is fixed, which is required by some very sensitive loads.

Set the function:

The function could be enabled through the LCD setting in Bypass mode. Enter the power strategy setting menu by following chapter of 5.3.

6.3. Parallel Function

Brief introduction of the redundancy:

N+X is currently the most reliable power supply structure. N represents the minimum UPS number that the total load needs, X represents the redundant UPS number, i.e. the fault UPS number that the system can handle simultaneously. When the X is larger, the reliability of the power system is higher. For occasions where reliability is highly depended on, N+X is the optimal mode.

As long as the UPS is equipped with parallel cables, up to 4 UPS can be connected in parallel to realize output power sharing and power redundancy.

How to install a new parallel UPS system:

- 1) Before installing a new parallel UPS system, user need to prepare input and output wires, input and output breaker, main maintenance bypass switch.
- 2) Remove the cover plate of the parallel port on the UPS, connect each UPS one by one with the parallel cable, and re-screw the Parallel port cover which is supplied in the accessories. See Fig.6-1.
- 3) Strictly follow the chapter of 4.4, the wiring requirement of single UPS to perform the wiring of each UPS.
- 4) Connect the output wires of each UPS to an output breaker panel.
- 5) **Disconnect the Jumper on J1 and J2 first**, and connect each output breaker to a Parallel output breaker and then to the loads.
- 6) **Each UPS needs an independent battery pack.**
- 7) Please refer to the wiring diagram in the following diagram. See Fig.6-2, Fig.6-3.

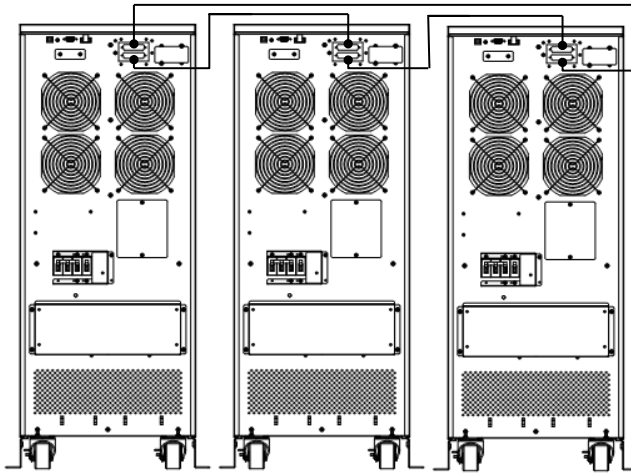

Fig.6-1 Parallel cable connect diagram

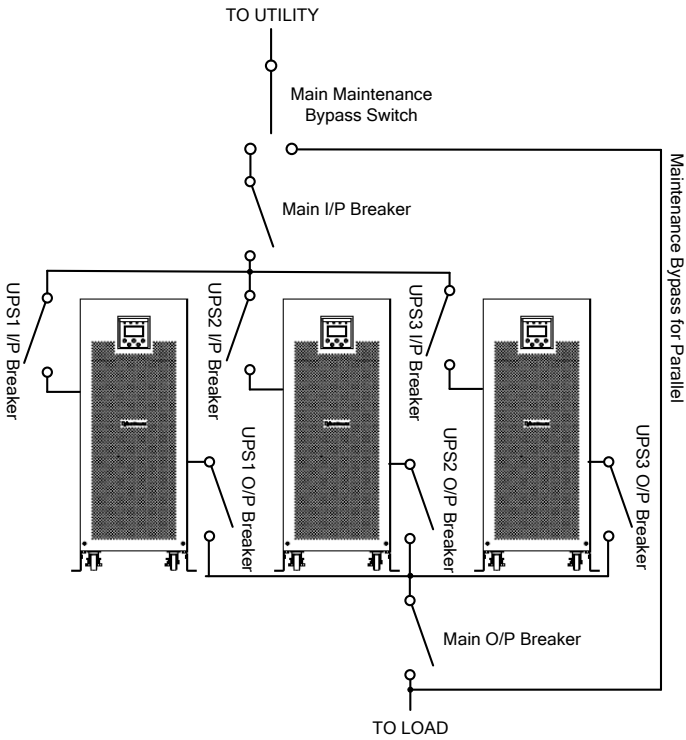





Fig.6-2 Parallel installation diagram

- 10) Press the button  of one UPS, each UPS would start to turn on, all the UPS would transfer to the Line mode together. Measure the output voltage of each UPS separately to check if the voltage difference between them is less than 0.5V. If the difference is more than 0.5V, the UPS need to be regulated.
- 11) Press the button  of one UPS, each UPS would start to turn off and transfer to the Bypass mode, switch on the output breaker of each UPS to parallel all the output of UPS together.
- 12) Press the button  of one UPS, each UPS would start to turn on , after turning on, the UPS should work parallel in the Line mode.

How to join a new UPS to a parallel system:

- 1) First the parallel system must be installed one main maintenance bypass switch.
- 2) Regulate the output voltage of the new UPS separately: check if the output voltage difference between the new UPS and the parallel system is less than 0.5V.
- 3) Ensure the bypass of the parallel system is normal and the bypass setting is "enable", remove the cover plate of maintenance bypass switch on the rear panel of each UPS, the UPS system would transfer to bypass automatically. Set the own maintenance bypass switch of each UPS from "UPS" to "BPS".
- 4) Set the main maintenance bypass switch from "UPS" to "BPS", switch off the main output breaker and the main input breaker, the UPS would shut down.
- 5) Ensure the UPS shut down totally, add the new UPS and reinstall the new UPS parallel system by following step 1) to 9) of the last chapter- "How to install a new parallel UPS system".
- 6) Switch on the main input breaker and the main output breaker, and set the main maintenance bypass switch from "BPS" to "UPS", then set the UPS own maintenance bypass switch from "BPS" to "UPS" and screw the maintenance cover plate back again. Press the button  of one UPS, each UPS would start to turn on, after turning on, the UPS should work parallel in the Line mode.

How to remove a single UPS from a parallel system:

- 1) First the parallel system must be installed one main maintenance bypass switch.
- 2) Ensure the bypass of the parallel system is normal and the bypass setting is "enable", remove the cover plate of maintenance bypass switch on the rear panel of each UPS, the UPS system would transfer to bypass automatically. Set the own maintenance bypass switch of each UPS from "UPS" to "BPS".

- 3) Set the main maintenance bypass switch from "UPS" to "BPS", switch off the main output breaker and the main input breaker, the UPS would shut down.
- 4) Ensure the UPS shut down totally, remove the wanted UPS and reinstall the new UPS parallel system by following step 1) to 9) of the last chapter- "How to install a new parallel UPS system".
- 5) Switch on the main input breaker and the main output breaker, and set the main maintenance bypass switch from "BPS" to "UPS", then set the UPS own maintenance bypass switch from "BPS" to "UPS" and screw the maintenance cover plate back again. Press the button  of one UPS, each UPS would start to turn on, after turning on, the UPS should work parallel in the Line mode.

7. Trouble Shooting

If the UPS system does not operate correctly, first check the operating information on the LCD display. Please attempt to solve the problem using the table below. If the problem still persists, consult your dealer.

7.1. Trouble Shooting According to Warning Indication

Problem Displayed	Possible Cause	Remedy
EPO active	EPO connector is open	Check the EPO connector status
Maintain on	Maintain bypass switch is open	Check the maintain bypass switch status
Phase unbalance	Input parameter voltage of R/S/T is unbalance	Check the Input parameter voltage of R/S/T
Fan warning	Fan blocked or disconnected	Check the fan status
Battery volt low	Battery voltage is low	When audible alarm sounding every second, battery is almost empty
Battery open	Battery is disconnect	Check the battery is connected to the UPS; Check the battery breaker is turn on

Bat over voltage	Battery voltage is higher than normal	Check if the battery quantity is right
Over charged	Battery is over charged	The UPS will turn off the charger until the battery voltage is normal
Over load	Over load	Check the loads and remove some non-critical loads; Check if some loads are failed
Charger fail	The charger fails	Consult dealer
Amb NTC abnormal	The ambient temperature is too high	Check the environment ventilation
Over temperature	Inside temperature of UPS is too high	Check the ventilation of UPS and the ambient temperature
Cable disconnect	The parallel cable is disconnected	Check the parallel cable
Cable loss	The parallel cable is disconnected	Check the parallel cable
Line differ	The mains input of some UPS is disconnected	Check the building wiring and input cable; Check if the input breaker is closed ;Ensure the UPS are connected to same input source
Work Mode differ	Different power strategy setting in parallel system	The UPS with different power strategy setting (Ex. one Line mode and one Converter mode) are forbidden to parallel
Battery differ	The battery packs of some UPS are disconnected	Check if all the battery pack is connected

Bypass differ	The Main2 bypass input of some UPS is disconnected	Check the building wiring and input cable. Check if the M2 breaker is closed. Ensure the UPS are connected to same input source
Setting differ	different setting in parallel system	Check the setting
ECO In Parallel	ECO function is enabled in parallel system	ECO function is forbidden in parallel system

7.2. Trouble Shooting According to Fault Indication

Problem Displayed	Possible Cause	Remedy
Output short	Output short circuit	Remove all the loads. Turn off the UPS. Check if UPS output and loads is short circuit. Ensure short circuit is removed before turning on again.
Over load	Over load	Check the loads and remove some non-critical loads. Check if some loads are failed.
Neg power fail	The load is pure inductive and capacitive	Remove some non-critical loads. Bypass supplies the load first, ensure there is no overload, then turn on UPS.
Over temperature	Inside temperature of UPS is too high	Check the ventilation of UPS and the ambient temperature
Fan fail	Fan blocked or disconnected over time	Check the fan status
Back feed	Output voltage is returned to input	Consult dealer
DC short	Bus short	Consult dealer.
DC over	Bus over voltage	Consult dealer.

DC under	Bus under Voltage	Consult dealer.
DC unbalance	Bus unbalance	Consult dealer.
DC soft fail	Bus soft start fail	Consult dealer.
Output soft fail	Output soft start fail	Consult dealer.
Output volt low	Output volt low	Consult dealer.
Output volt high	Output volt high	Consult dealer.

7.3. Trouble Shooting in Else Cases

Problem	Possible Cause	Remedy
No indication, no warning tone even though system is connected to mains power supply	No input voltage	Check the building wiring and input cable. Check if the input breaker is closed
BYPASS LED light up even though the power supply is available	Inverter not switched on	Press button  to turn on UPS
BATTERY LED lights up, and audible alarm sounding every 1 beep in every 4 seconds	Input voltage and/or frequency are out of tolerance	Check input power source Check the building wiring and input cable Check if the input breaker is closed
Emergency supply period shorter than nominal value	Batteries not fully charged / batteries defect	Charge the batteries at least 12 hours and then check capacity

Please have the following information at hand before calling the After-Sales Service Department:

- 1) Model number, serial number.
- 2) Date on which the problem occurred.
- 3) LCD/LED display information, Buzzer alarm status.
- 4) Mains power condition, load type and capacity, environment temperature,

ventilation condition.

- 5) The information (battery capacity, quantity) of external battery pack if the UPS is "XL" model.
- 6) Other information for complete description of the problem.

8. Battery Maintenance

Battery replacement should be performed by qualified personnel.

- This series UPS only requires minimal maintenance. The battery used for standard models are value regulated sealed lead-acid maintenance free battery. These models require minimal repairs. The only requirement is to charge the UPS regularly in order to maximize the expected life of the battery. When being connected to the utility power, whether the UPS is turned on or not, the UPS keeps charging the batteries and also offers the protective function of overcharging and over-discharging.
- The UPS should be charged once every 4 to 6 months if it has not been used for a long time.
- In the regions of hot climates, the battery should be charged and discharged every 2 months. The standard charging time should be at least 12 hours.
- Under normal conditions, the battery life lasts 3 to 5 years. In case if the battery is found not in good condition, earlier replacement should be made. Battery replacement should be performed by qualified personnel.
- Replace batteries with the same number and same type of batteries.
- Do not replace the battery individually. All the batteries should be replaced at the same time following the instructions of the battery supplier.
- Normally, the batteries should be charged and discharged once every 4 to 6 months. Charging should begin after the UPS shuts down automatically in the course of discharging, the standard charging time for the standard UPS should be at least 12 hours.

8.1. Replacement and Disposal of Batteries

- Before disposing of batteries, remove conductive jewelry such as necklace, wrist watches and rings.
- If it is necessary to replace any connection cables, please purchase the original

materials from the authorized distributors or service centers, so as to avoid overheat or spark resulting in fire due to insufficient capacity.

- Do not dispose of batteries or battery packs in a fire, they may explode.
- Do not open or mutilate batteries, released electrolyte is highly poisonous and harmful to the skin and eyes.
- Do not short the positive and negative of the battery electrode, otherwise, it may result in electric shock or fire.
- Make sure that there is no voltage before touching the batteries. The battery circuit is not isolated from the input potential circuit. There may be hazardous voltage between the battery terminals and the ground.
- Even though the input breaker is disconnected, the components inside the UPS are still connected with the batteries, and there are potential hazardous voltages. Therefore, before any maintenance and repairs work is carried out, switch off the breaker of the battery pack or disconnect the jumper wire of connecting between the batteries.
- Batteries contain hazardous voltage and current. Battery maintenance such as the battery replacement must be carried out by qualified personnel who are knowledgeable about batteries. No other persons should handle the batteries.

8.2. Easy for Battery Replacement

Note: The battery pack is 20kg weight, be careful not to fall off when operate the battery replacement.

If you want to replace batteries without powering down the UPS, you need to set the UPS work in Bypass Mode. That is to remove the maintenance bypass switch cover plate of UPS and set the maintenance bypass switch from "UPS" to "BPS", turn the M1/M2/N input breaker in the "OFF" position(you need open the N breaker's cover at first), and then you can replace it.

Open the front panel and request service engineer to replace batteries. Steps:

- 1) Remove front panel and disconnect the connector on the LCD display board.

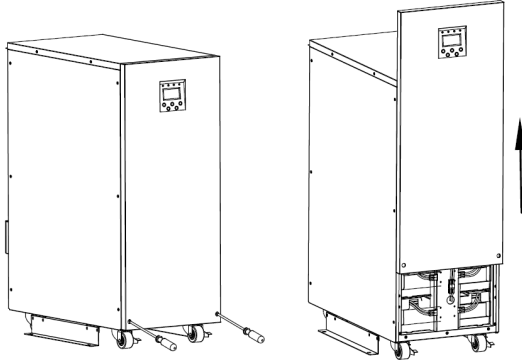

- 2) Disconnect the battery pack DC connectors and remove the battery fixed plate.

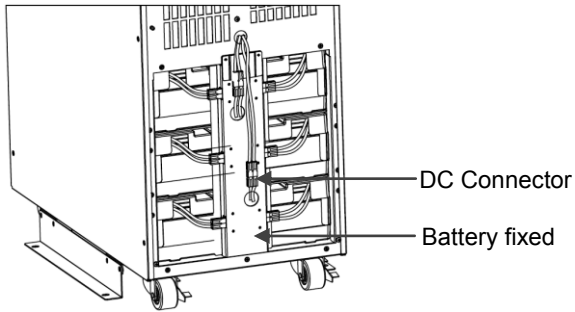

- 3) Remove the battery pack from the cabinet.

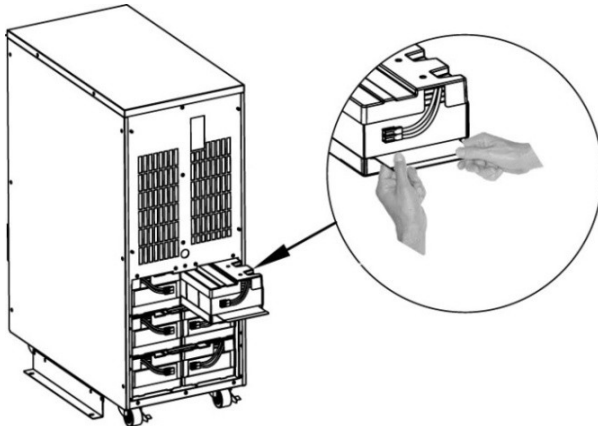

- 4) Replace the old battery packs with the new ones.
- 5) Reconnect the DC cables.

9. Communication Port

9.1. USB Interface

The USB port is compliance with USB 1.1 protocol for its communication software.

9.2. Dry contact Interface(optional)

This series UPS has independent dry contact interface. Please contact your local distributor for details.

9.3. RS232 Interface

The RS232 port is available for UPS monitoring, control, and firmware updates.

9.4. Intelligent slot

This series is equipped with an intelligent slot for other optional card to achieve remote management of the UPS through internet / intranet. Please contact your local distributor for further information.

CyberPower Systems Inc.

www.cyberpower.com

6F, No. 32, Sec. 1, Chenggong Rd., Nangang District, Taipei 115, Taiwan

Entire contents copyright© 2013 CyberPower Systems Inc., All rights reserved. Reproduction in whole or in part without permission is prohibited. PowerPanel® Business Edition and PowerPanel® Personal Edition are trademarks of CyberPower Systems Inc.