

Tescom

TEOS SERIES

TEOS 106(XL) - 110(XL)
TEOS 106RT(XL) - 110RT(XL)

Online UPS

Uninterruptible Power Supply System

User Manual



Please comply with all warnings and operating instructions in this manual strictly. Save this manual properly and read carefully the following instructions before installing the unit. Do not operate this unit before reading through all safety information and operating instructions carefully.

Table of Contents

1. SAFETY AND EMC INSTRUCTIONS	1
1-1. TRANSPORTATION AND STORAGE	1
1-2. PREPARATION	1
1-3. INSTALLATION	1
1-4.  CONNECTION WARNINGS	2
1-5. OPERATION	3
1-6. STANDARDS	3
2. INSTALLATION AND OPERATION	4
2-1. UNPACKING AND INSPECTION	4
2-2. REAR PANEL VIEW	4
2-3. SINGLE UPS INSTALLATION	4
2-4. SOFTWARE INSTALLATION	7
3. OPERATIONS	8
3-1. BUTTON OPERATION	8
3-2. LED INDICATORS AND LCD PANEL	8
3-3. AUDIBLE ALARM	10
3-4. SINGLE UPS OPERATION	10
3-5. ABBREVIATION MEANING IN LCD DISPLAY	12
3-6. LCD SETTING	14
3-7. OPERATING MODE/STATUS DESCRIPTION	19
3-8. FAULT CODE	20
3-9. WARNING INDICATOR	20
4. TROUBLE SHOOTING	21
5. STORAGE AND MAINTENANCE	22
5-1. STORAGE	22
5-2. MAINTENANCE	22
6. SPECIFICATIONS	23

1. Safety and EMC instructions

Please read carefully the following user manual and the safety instructions before installing the unit or using the unit!

1-1. Transportation and Storage



Please transport the UPS system only in the original package to protect against shock and impact.



The UPS must be stored in the room where it is ventilated and dry.

1-2. Preparation



Condensation may occur if the UPS system is moved directly from cold to warm environment. The UPS system must be absolutely dry before being installed. Please allow at least two hours for the UPS system to acclimate the environment.



Do not install the UPS system near water or in moist environments.



Do not install the UPS system where it would be exposed to direct sunlight or nearby heater.



Do not block ventilation holes in the UPS housing.

1-3. Installation



Do not connect appliances or devices which would overload the UPS (e.g. big motor-type equipment)) to the UPS output sockets or terminal.



Place cables in such a way that no one can step on or trip over them.



Do not block air vents in the housing of UPS. The UPS must be installed in a location with good ventilation. Ensure enough space on each side for ventilation.



UPS has provided earthed terminal, in the final installed system configuration, equipotential earth bonding to the external UPS battery cabinets.



The UPS can be installed only by qualified maintenance personnel.



An appropriate disconnect device as short-circuit backup protection should be provided in the building wiring installation.



An integral single emergency switching device which prevents further supply to the load by the UPS in any mode of operation should be provided in the building wiring installation.



Connect the earth before connecting to the building wiring terminal.



Installation and Wiring must be performed in accordance with the local electrical laws and regulations.

1-4. Connection Warnings

- There is no standard backfeed protection inside, please isolate the UPS before working according to this circuit. The isolation device must be able to carry the UPS input current.

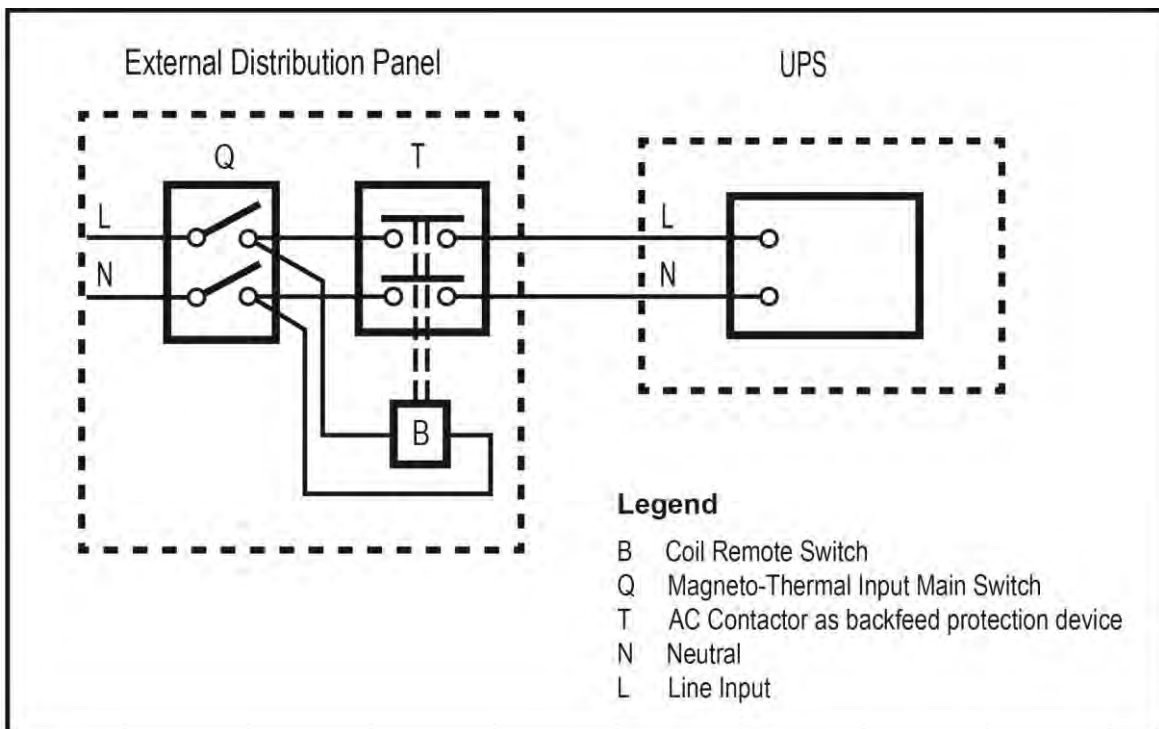

- This UPS should be connected with TN earthing system.
- The power supply for this unit must be single-phase rated in accordance with the equipment nameplate. It also must be suitably grounded.
- Use of this equipment in life support applications where failure of this equipment can reasonably be expected to cause the failure of the life support equipment or to significantly affect its safety or effectiveness is not recommended. Do not use this equipment in the presence of a flammable anesthetic mixture with air, oxygen or nitrous oxide.
- Connect your UPS power module's grounding terminal to a grounding electrode conductor.**
- The UPS is connected to a DC energy source (battery). The output terminals may be live when the UPS is not connected to an AC supply.

Before working on this circuit

- Isolate Uninterruptible Power System (UPS)
- Then check for Hazardous Voltage between all terminals including the protective earth.

 Risk of Voltage Backfeed

1-5. Operation



Do not disconnect the earth conductor cable on the UPS or the building wiring terminals in any time since this would cancel the protective earth of the UPS system and of all connected loads.



The UPS system features its own, internal current source (batteries). The UPS output sockets or output terminal blocks may be electrically live even if the UPS system is not connected to the building wiring outlet.



In order to fully disconnect the UPS system, first press the "OFF" button and then disconnect the mains.



Ensure that no liquid or other foreign objects can enter into the UPS system.



The UPS can be operated by any individuals with no previous experience.

1-6. Standards

* Safety	
IEC/EN 62040-1	
* EMI	
Conducted Emission.....: IEC/EN 62040-2	Category C3
Radiated Emission.....: IEC/EN 62040-2	Category C3
* EMS	
ESD.....: IEC/EN 61000-4-2	Level 4
RS..... : IEC/EN 61000-4-3	Level 3
EFT..... : IEC/EN 61000-4-4	Level 4
SURGE..... : IEC/EN 61000-4-5	Level 4
CS..... : IEC/EN 61000-4-6	Level 3
Power-frequency Magnetic field..... : IEC/EN 61000-4-8	Level 4
Low Frequency Signals.....: IEC/EN 61000-2-2	
Warning: This is a product for commercial and industrial application in the second environment-installation restrictions or additional measures may be needed to prevent disturbances.	

2. Installation and Operation

There are two different types of online UPS: standard and long-run models. Please refer to the following model table.

Model	Type	Model	Type
6K	Standard model	6KL	Long-run model
6KR			
10K			
10KR			
		6KRL	
		10KL	
		10KRL	

2-1. Unpacking and Inspection

Unpack the package and check the package contents. The shipping package contains:

- One UPS
- One user manual
- **One monitoring software CD**
- One RS-232 cable (option)
- One USB cable
- **One battery cable (option)**

NOTE: Before installation, please inspect the unit. Be sure that nothing inside the package is damaged during transportation. Do not turn on the unit and notify the carrier and dealer immediately if there is any damage or lacking of some parts. Please keep the original package in a safe place for future use.

2-2. Rear Panel View

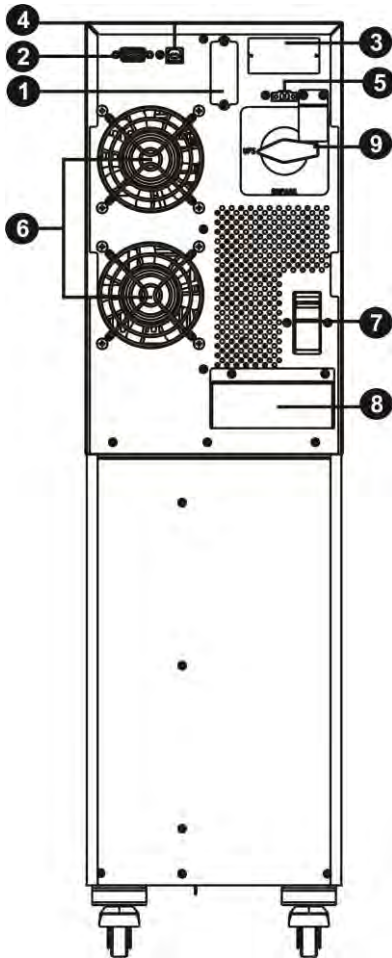

Diagram1: 6K/10K Rear Panel

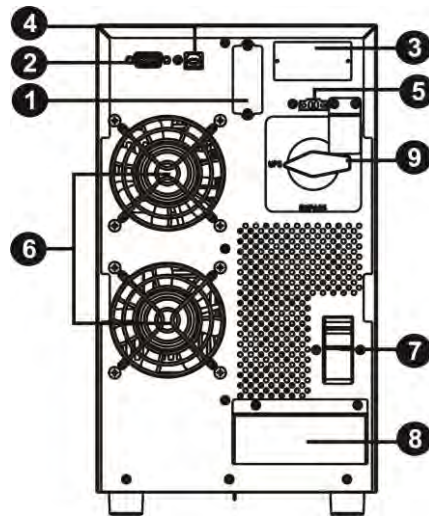

Diagram 2: 6KL/10KL Rear Panel

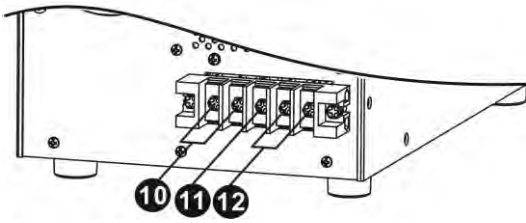

Diagram 3: Tower Input/Output Terminal

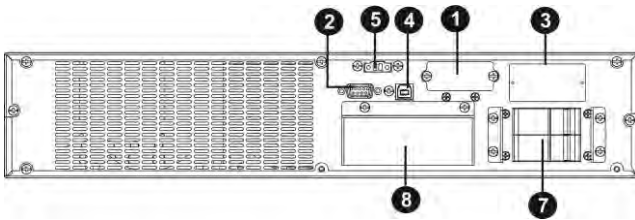

Diagram 4: 6KR(L) Rear Panel

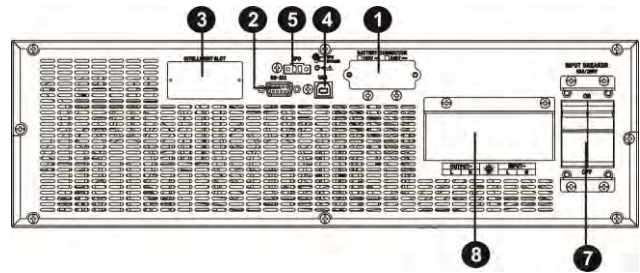

Diagram 5: 10KR(L) Rear Panel

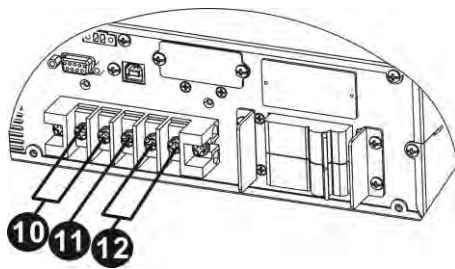

Diagram 6: Rack Input/Output Terminal

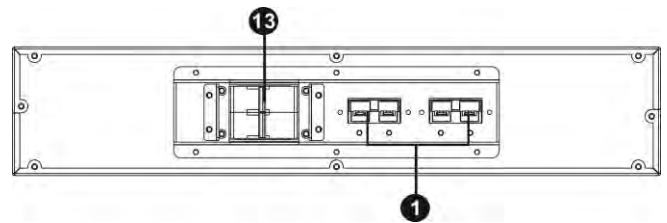

Diagram 7: 2U Battery Pack Rear Panel

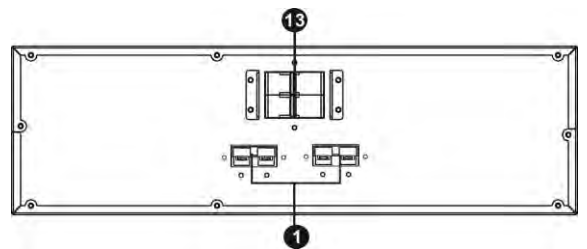

Diagram 8: 3U Battery Pack Rear Panel

1. External battery connector
2. RS-232 communication port
3. Intelligent slot
4. USB communication
5. Emergency power off function connector (EPO connector)
6. Cooling fan
7. Input circuit breaker
8. Input/Output terminal (Refer to Diagram 3 and 6 for the details)
9. Maintenance bypass switch (option)
10. Output terminal
11. Grounding terminal
12. Utility input terminal
13. Battery pack output circuit breaker

2-3. Single UPS Installation

Installation and wiring must be performed in accordance with the local electric laws/regulations and execute the following instructions by professional personnel.

1) Make sure the mains wire and breakers in the building are in compliance with the standard of rated capacity of UPS to avoid the hazards of electric shock or fire.

NOTE: Do not use the wall receptacle as the input power source for the UPS, as its rated current is less than **the UPS's maximum input current. Otherwise the receptacle may be burned and destroyed.**

2) Switch off the mains switch in the building before installation.

- 3) Turn off all the connected devices before connecting to the UPS.
- 4) Prepare wires based on the following table:

Model	Wiring spec (AWG)			
	Input	Output	Battery	Ground
6K/6KR	10	12		12
6KL/6KRL	10	12	12	12
10K/10KR	8	8		8
10KL/10KRL	8	8	8	8

NOTE 1: It is recommended to use suitable wire in above table or thicker for safety and efficiency.

NOTE 2: The selections for color of wires should be followed by the local electrical laws and regulations.

- 5) Remove the terminal block cover on the rear panel of UPS. Then connect the wires according to the following terminal block diagrams: (Connect the earth wire first when making wire connection. Disconnect the earth wire last when making wire disconnection!)

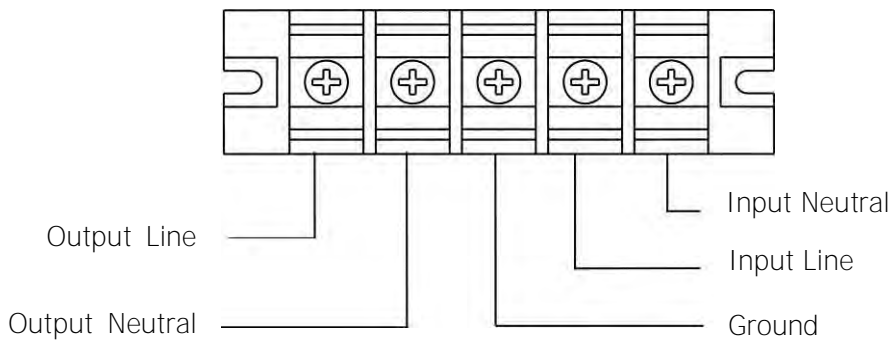

Terminal Block wiring diagram

NOTE 1: Make sure that the wires are connected tightly with the terminals.

NOTE 2: Please install the output breaker between the output terminal and the load, and the breaker should be qualified with leakage current protective function if necessary.

- 6) Put the terminal block cover back to the rear panel of the UPS.



Warning: (Only for standard model)

- **Make sure the UPS is not turned on before installation. The UPS** should not be turned on during wiring connection.
- **Do not try to modify the standard model to the long-run model.** Particularly, do not try to connect the standard internal battery to the external battery. The battery type and voltage and numbers may be different. If you connect them together, it maybe causes the hazard of electric shock or fire!



Warning: (Only for long-run model)

- **Make sure a DC breaker** or other protection device between UPS and external battery pack is installed. If not, please install it carefully. Switch off the battery breaker before installation.



Warning:

- For standard battery pack, there are one DC breaker to disconnect the battery pack and the UPS. But for

other external battery pack, make sure a DC breaker or other protection device between UPS and external battery pack is installed. If not, please install it carefully. Switch off the battery breaker before installation.

NOTE: Set the battery pack breaker in "OFF" position and then install the battery pack.

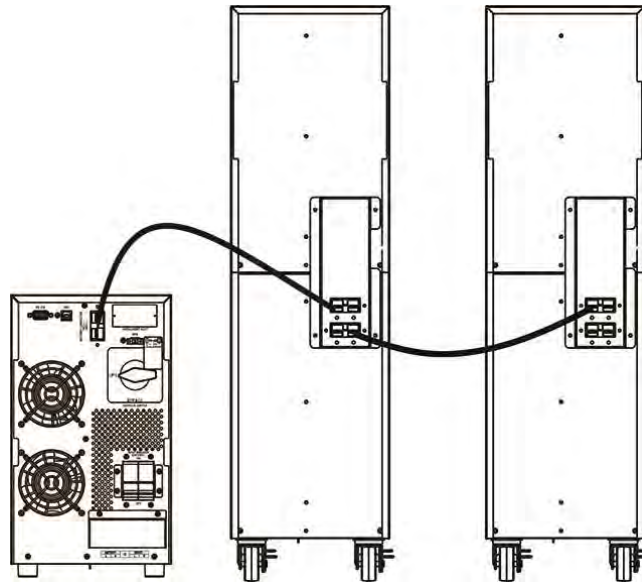

- **Pay highly attention to the rated battery voltage** marked on the rear panel. If you want to change the numbers of the battery pack, please make sure you modify the jumper setting on control board simultaneously. The connection with wrong battery voltage may cause permanent damage of the UPS. Make sure the voltage of the battery pack is correct.
- **Pay highly attention to the polarity marking on external battery terminal block, and make sure the correct battery polarity is connected.** Wrong connection may cause permanent damage of the UPS.
- **Make sure the protective earth ground wiring is correct.** The current spec, color, position, connection and conductance reliability of wire should be checked carefully.
- **Make sure the utility input & output wiring is correct.** The current spec, color, position, connection and conductance reliability of wire should be checked carefully. Make sure the L/N terminal is correct, not reverse or short-circuited.

2-4. Software Installation

For optimal computer system protection, install UPS monitoring software to fully configure UPS shutdown.

3. Operations

3-1. Button Operation

Button	Function
ON/Enter Button	<ul style="list-style-type: none"> ➤ Turn on the UPS: Press and hold the button more than 1s to turn on the UPS. ➤ Enter Key: Press this button to confirm the selection in setting menu.
OFF/ESC Button	<ul style="list-style-type: none"> ➤ Turn off the UPS: Press and hold the button more than 1s to turn off the UPS. ➤ Esc key: Press this button to return to last menu in setting menu.
Test/Up Button	<ul style="list-style-type: none"> ➤ Battery test: Press and hold the button more than 1s to test the battery while in AC mode, or CVCF mode. ➤ UP key: Press this button to display next selection in setting menu.
Mute/Down Button	<ul style="list-style-type: none"> ➤ Mute the alarm: Press and hold the button more than 1s to mute the buzzer. Please refer to section 3-4 "Mute the buzzer" for details. ➤ Down key: Press this button to display previous selection in setting menu.
Test/Up + Mute/Down Button	<ul style="list-style-type: none"> ➤ Press and hold the two buttons simultaneous more than 1s to enter/escape the setting menu.

* CVCF mode means converter mode.

3-2. LED Indicators and LCD Panel

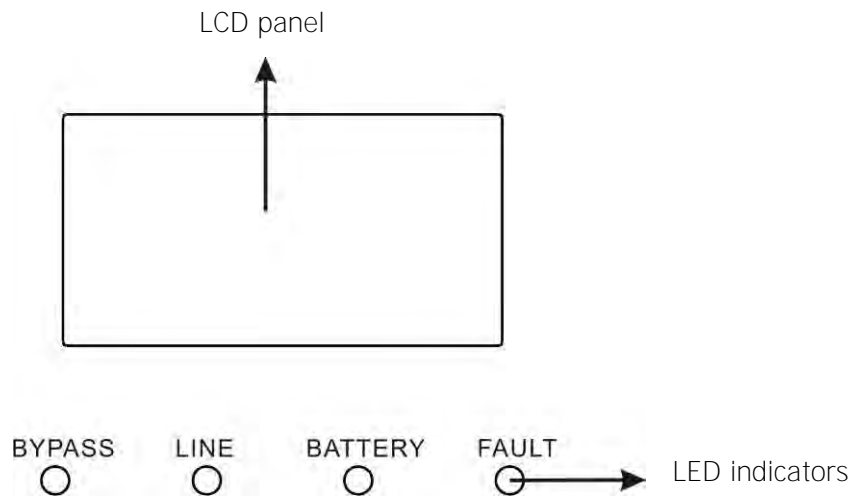

LED Indicators:

There are 4 LEDs on front panel to show the UPS working status:



Mode \ LED	Bypass	Line	Battery	Fault
UPS Startup	●	●	●	●
Bypass mode	●	○	○	○
AC mode	○	●	○	○
Battery mode	○	○	●	○
CVCF mode	○	●	○	○
Battery Test	●	●	●	○
Fault	○	○	○	●

Note: ● means LED is lighting, and ○ means LED is faded.

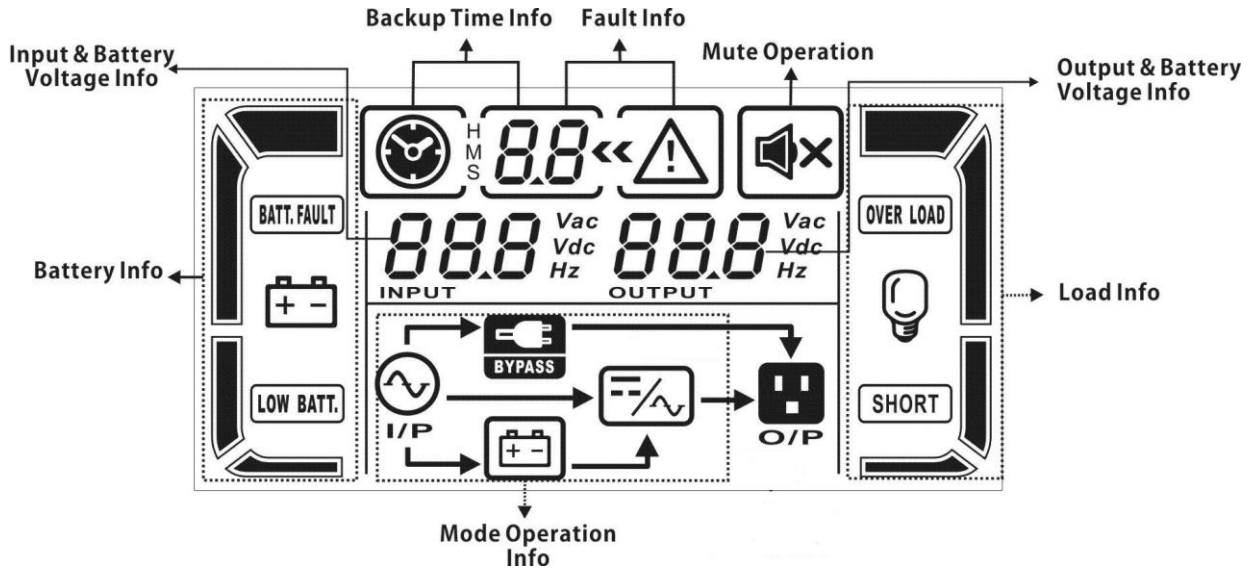
LCD Panel:

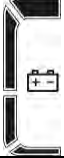

Display	Function
Backup time information	
	Indicates the backup time in numbers. H: hours, M: minutes, S: seconds
Fault information	
	Indicates that the warning and fault occurs.
	Indicates the fault codes, and the codes are listed in details in section 3-9.
Mute operation	
	Indicates that the UPS alarm is disabled.
Output & Battery voltage information	
	Indicates the output voltage, frequency or battery voltage. Vac: output voltage, Vdc: battery voltage, Hz: frequency
Load information	
	Indicates the load level by 0-25%, 26-50%, 51-75%, and 76-100%.
	Indicates overload.
	Indicates the load or the output is short.
Mode operation information	
	Indicates the UPS connects to the mains.
	Indicates the battery is working.
	Indicates the bypass circuit is working.
	Indicates the Inverter circuit is working.
	Indicates the output is working.

Battery information	
	Indicates the Battery capacity by 0-25%, 26-50%, 51-75%, and 76-100%.
BATT. FAULT	Indicates the battery is fault.
LOW BATT.	Indicates low battery level and low battery voltage.
Input & Battery voltage information	
	Indicates the input voltage or frequency or battery voltage. Vac: Input voltage, Vdc: battery voltage, Hz: input frequency

3-3. Audible Alarm

Description	Buzzer status	Muted
UPS status		
Bypass mode	Beeping once every 2 minutes	Yes
Battery mode	Beeping once every 4 seconds	
Fault mode	Beeping continuously	
Warning		
Overload	Beeping twice every second	No
Low battery	Beeping once every second	
Battery unconnected		
Over charge		
EPO enable		
Fan failure/Over temperature		
Charger failure		
Overload 3 times in 30min		
EPO status		
Cover of maintain switch is open		
Fault		
Bus start failure	Beeping continuously	Yes
Bus over		
Bus under		
Bus unbalance		
Inverter soft start failure		
High Inverter voltage		
Low Inverter voltage		
Inverter output short circuited		
Battery SCR short circuited		
Over temperature		
Overload		

3-4. Single UPS Operation

1. Turn on the UPS with utility power supply (in AC mode)

- 1) After power supply is connected correctly, set the breaker of the battery pack at "ON" position (the step only available for long-run model). Then, set the input breaker at "ON" position. At this time, the fan is running and the UPS supplies power to the loads via the bypass. The UPS is operating in Bypass mode.

NOTE: When UPS is in Bypass mode, the output voltage will directly power from utility after you switch on the input breaker. In Bypass mode, the load is not protected by UPS. To protect your precious devices, you should turn on the UPS. Refer to next step.

- 2) Press and hold **the "ON" button for** 1s to turn on the UPS and the buzzer will beep once.
- 3) A few seconds later, the UPS will enter to AC mode. If the utility power is abnormal, the UPS will operate in Battery mode without interruption.

NOTE: When the UPS is running out battery, it will shut down automatically at Battery mode. When the utility power is restored, the UPS will auto restart in AC mode.

2. Turn on the UPS without utility power supply (in Battery mode)

- 1) Make sure that the breaker of the battery pack is at "ON" position (only for long-run model).
- 2) Press and hold **the "ON" button for** 1s to turn on the UPS, and the buzzer will beep once.
- 3) A few seconds later, the UPS will be turned on and enter to Battery mode.

3. Connect devices to UPS

After the UPS is turned on, you can connect devices to the UPS.

- 1) Switch on the devices one by one and it will display total load level in LCD panel.
- 2) If it is necessary to connect the inductive loads such as a printer, the in-rush current should be calculated carefully to see if it meets the capacity of the UPS, because the power consumption of this kind of loads is too big.
- 3) If the UPS is overload, the buzzer will beep twice every second.
- 4) When the UPS is overload, please remove some loads immediately. It is recommended to have the total loads connected to the UPS less than 80% of its nominal power capacity to prevent overload for system safety.
- 5) If the overload time is over acceptable time listed in spec at AC mode, the UPS will automatically transfer to Bypass mode. After the overload is removed, it will return to AC mode. If the overload occurs 3 times in half hour, the UPS will be locked in Bypass mode. UPS can transfer to Line mode only by manual restart. At this time, if bypass is enabled, the UPS will power to the load via bypass. If bypass function is disabled or the input power is not within bypass acceptable range, it will cut off output directly.

4. Charge the batteries

- 1) After the UPS is connected to the utility power, the charger will charge the batteries automatically except in Battery mode or during battery self-test.
- 2) It's suggested to charge batteries at least 10 hours before use. Otherwise, the backup time may be shorter than expected time.
- 3) Make sure the battery numbers setting on the control board (Please refer to the section 3-4-11 for detailed setting) is the same to the real-connection.
- 4) The charging current can be changed from 1A to 6A via LCD or software. Please make sure that the charging current is suitable to battery specification.

5. Battery mode operation

- 1) When the UPS is in Battery mode, the buzzer will beep according to different battery capacity. If the battery capacity is more than 25%, the buzzer will beep once every 4 seconds. If the battery voltage drops to the alarm level, the buzzer will beep quickly (once every sec) to remind users that the battery is at low level and the UPS will shut down automatically soon. Users could switch off some non-critical loads to disable the shutdown alarm and prolong the backup time. If there is no more load to be switched off at that time, you have to shut down all loads as soon as possible to protect the devices or save data. Otherwise, there is a risk of data loss or power failure.
- 2) In Battery mode, if buzzer sound annoys, users can press the Mute button to mute the buzzer.

- 3) The backup time of the long-run model depends on the external battery capacity.
- 4) The backup time may vary from different environment temperature and load type.
- 5) When setting backup time for 16.5 hours (default value from LCD panel), after discharging 16.5 hours, UPS will shut down automatically to protect the battery. This battery discharge protection can be enabled or disabled through LCD panel control. (Refer to 3-7 LCD setting section)

6. Turn off the UPS with utility power supply in AC mode

- 1) Turn off the inverter of the UPS by pressing **"OFF" button for at least 1s**, and then the buzzer will beep once. The UPS will turn into Bypass mode.

NOTE 1: If the UPS has been set to enable the bypass output, it will bypass voltage from utility power to output sockets and terminal even though you have turned off the UPS (inverter).

NOTE 2: After turning off the UPS, please be aware that the UPS is working at Bypass mode and there is risk of power loss for connected devices.

- 2) In Bypass mode, output voltage of the UPS is still present. In order to cut off the output, switch off the input breaker. A few seconds later, there is no display shown on the LCD panel and UPS is complete off.

7. Turn off the UPS without utility power supply in Battery mode

- 1) Turn off the UPS by pressing **"OFF" button for at least 1s**, and then the buzzer will beep once.
- 2) Then UPS will cut off power to output and there is no display shown on the display panel.

8. Mute the buzzer

- 1) **To mute the buzzer, please press the "Mute" button for at least 1s**. If you press it again after the buzzer is muted, the buzzer will beep again.
- 2) Some warning alarms **can't be muted unless the** error is fixed. Please refer to section 3-3 for the details.

9. Operation in warning status

- 1) When Fault LED flashes and the buzzer beeps once every second, it means that there are some problems for UPS operation. Users can get the fault code from LCD panel. Please check the trouble shooting table in chapter 4 for details.
- 2) Some warning alarms **can't be muted unless the** error is fixed. Please refer to section 3-3 for the details.

10. Operation in Fault mode

- 1) When Fault LED illuminates and the buzzer beeps continuously, it means that there is a fatal error in the UPS. Users can get the fault code from display panel. Please check the trouble shooting table in chapter 4 for details.
- 2) Please check the loads, wiring, ventilation, utility, battery and so on after the **fault occurs. Don't try to turn on the UPS again before solving the problems. If the problems can't be fixed, please contact the distributor or service people immediately.**
- 3) For emergency case, please cut off the connection from utility, external battery and output immediately to avoid more risk or danger.

11. Operation of changing battery numbers

- 1) This operation is only available for professional or qualified technicians.
- 2) **Turn off the UPS. If the load couldn't be cut off**, you should remove the cover of maintenance

bypass switch on the rear panel and turn the maintenance switch to "BPS" position first.

- 3) Switch off the input breaker, and switch off the battery breaker.
- 4) Remove the cabinet cover, and then modify the jumpers (CN1) on the control board to set the battery numbers as following table:

Battery Number	CN1					
	pin15	Pin16	Pin17	Pin18	Pin19	Pin20
16	X	1	0	0	0	0
17	X	0	1	0	0	0
18	X	0	0	1	0	0
19	X	0	0	0	1	0
20	X	0	0	0	0	1

Note: 1 = connect with jumper; 0 = no jumper; x = the pins are for other functions.

- 5) Modify the battery pack for the setting number carefully. After complete it, put the cover back, and switch on the battery breaker.
- 6) Switch on the input breaker and the UPS will enter Bypass mode. If the UPS is in maintenance Bypass mode, turn the maintenance switch to "UPS" position and then turn on the UPS.

3-5. Abbreviation Meaning in LCD Display

Abbreviation	Display content	Meaning
ENA		Enable
DIS		Disable
ATO		Auto
BAT		Battery
NCF		Normal mode (not CVCF mode)
CF		CVCF mode
SUB		Subtract
ADD		Add
ON		On
OFF		Off
FBD		Not allowed
OPN		Allow
RES		Reserved

3-6. LCD Setting

There are three parameters to set up the UPS. Refer to following diagram.

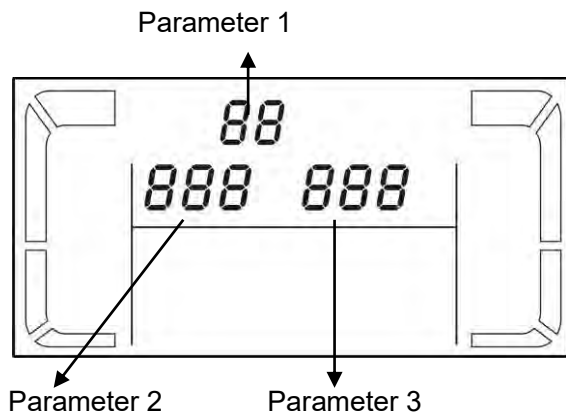

Parameter 1: It's for program alternatives. Refer to below table for the programs to set up.

Parameter 2 and parameter 3 are the setting options or values for each program.

Note: Please **select "Up" or "Down"** button to change the programs or parameters.

Programs available list for parameter 1:



Code	Description	Bypass	AC	CVCF	Battery	Battery Test
01	Output voltage	Y				
02	Output frequency	Y				
03	Voltage range for bypass	Y				
04	Frequency range for bypass	Y				
05	Reserved					
06	Reserved					
07	Reserved					
08	Bypass mode setting	Y	Y			
09	Battery maximum discharge time setting	Y	Y	Y	Y	Y
10	Reserved					
11	Reserved					
12	Reserved					
13	Battery voltage Calibration	Y	Y	Y	Y	Y
14	Reserved					
15	Inverter voltage Calibration		Y	Y	Y	
16	Floating charger voltage adjustment	Y	Y	Y	Y	Y
17	Constant charger voltage adjustment	Y	Y	Y	Y	Y
18	Charger maximum current setting	Y	Y	Y	Y	Y
19	Battery capacity and groups setting	Y	Y	Y	Y	Y
20	Backup time calibration	Y	Y	Y	Y	Y

*Y means that this program can be set in this mode.

● 01: Output voltage

Interface	Setting
	Parameter 3: Output voltage You may choose the following output voltage in parameter 3: 208: Presents output voltage is 208Vac 220: Presents output voltage is 220Vac 230: Presents output voltage is 230Vac 240: Presents output voltage is 240Vac

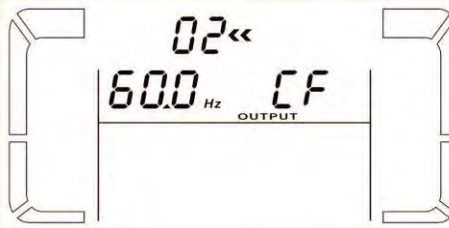
● 02: Output frequency

Interface	Setting
<p>60 Hz, CVCF mode</p>  <p>50 Hz, Normal mode</p>  <p>ATO</p> 	<p>Parameter 2: Output Frequency Setting the output frequency. You may choose following three options in parameter 2: 50.0Hz: The output frequency is setting for 50.0Hz. 60.0Hz: The output frequency is setting for 60.0Hz. ATO: If selected, output frequency will be decided according to the latest normal utility frequency. If it is from 46Hz to 54Hz, the output frequency will be 50.0Hz. If it is from 56Hz to 64Hz, the output frequency will be 60.0Hz. ATO is default setting.</p> <p>Parameter 3: Frequency mode Setting output frequency at CVCF mode or non-CVCF mode. You may choose following two options in parameter 3: CF: Setting UPS to CVCF mode. If selected, the output frequency will be fixed at 50Hz or 60Hz according to setting in parameter 2. The input frequency could be from 46Hz to 64Hz. NCF: Setting UPS to normal mode (non-CVCF mode). If selected, the output frequency will synchronize with the input frequency within 46~54 Hz at 50Hz or within 56~64 Hz at 60Hz according to setting in parameter 2. If 50 Hz selected in parameter 2, UPS will transfer to battery mode when input frequency is not within 46~54 Hz. If 60Hz selected in parameter 2, UPS will transfer to battery mode when input frequency is not within 56~64 Hz. *If Parameter 2 is ATO, the Parameter 3 will show the current frequency.</p>

● 03: Voltage range for bypass

Interface	Setting
	<p>Parameter 2: Set the acceptable low voltage for bypass. Setting range is from 110V to 209V and the default value is 110V. Parameter 3: Set the acceptable high voltage for bypass. Setting range is from 231V to 276V and the default value is 264V.</p>

● 04: Frequency range for bypass

Interface	Setting
	<p>Parameter 2: Set the acceptable low frequency for bypass. 50 Hz system: Setting range is from 46.0Hz to 49.0Hz. 60 Hz system: Setting range is from 56.0Hz to 59.0Hz. The default value is 46.0Hz/56.0Hz. Parameter 3: Set the acceptable high frequency for bypass. 50 Hz: Setting range is from 51.0Hz to 54.0 Hz. 60 Hz: Setting range is from 61.0Hz to 64.0Hz. The default value is 54.0Hz/64.0Hz.</p>

● 05: reserved

Interface	Setting
	<p>reserved</p>

- 06: reserved

Interface	Setting
	reserved

- 07: reserved

Interface	Setting
	reserved

- 08: Bypass mode setting

Interface	Setting
	<p>Parameter 2: OPN: Bypass allowed. When selected, UPS will run at Bypass mode depending on bypass enabled/disabled setting. FBD: Bypass not allowed. When selected, it's not allowed for running in Bypass mode under any situations.</p> <p>Parameter 3: ENA: Bypass enabled. When selected, Bypass mode is activated. DIS: Bypass disabled. When selected, automatic bypass is acceptable, but manual bypass is not allowed. Manual bypass means users manually operate UPS for Bypass mode. For example, pressing OFF button in AC mode to turn into Bypass mode.</p>

- 09: Battery maximum discharge time setting

Interface	Setting
	<p>Parameter 3: 000~999: Set the maximum discharge time from 0 min. to 999 min. UPS will shut down to protect battery after discharge time arrives. The default value is 990 min. DIS: Disable battery discharge protection and backup time will depend on battery capacity.</p>

- 10: reserved

Interface	Setting
	reserved

- 11: reserved

Interface	Setting
	reserved

- 12: reserved

Interface	Setting
	reserved

- 13: Battery voltage calibration

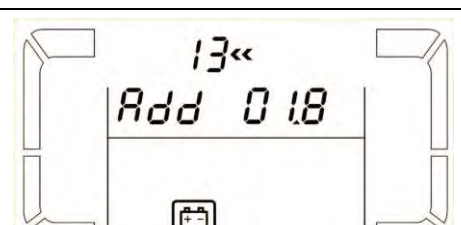
Interface	Setting
	Parameter 2: Select "Add" or "Sub" function to calibrate battery voltage to real figure. Parameter 3: The voltage setting range is from 0V to 5.7V. The default value is 0V.

- 14: reserved

Interface	Setting
	reserved

- 15: Inverter voltage calibration

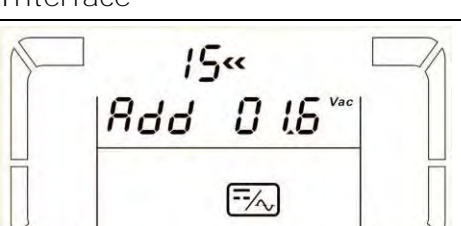
Interface	Setting
	Parameter 2: you may choose Add or Sub to calibrate inverter voltage Parameter 3: The voltage setting range is from 0V to 6.4V. The default value is 0V.

● 16: Floating charger voltage adjustment

Interface	Setting
	<p>Parameter 2: you may choose Add or Sub to adjust floating charger voltage.</p> <p>Parameter 3: the voltage range is from 0V to 8V, the default value is 0V.</p>

● 17: Constant charger voltage adjustment

Interface	Setting
	<p>Parameter 2: you may choose Add or Sub to adjust constant charger voltage.</p> <p>Parameter 3: the voltage range is from 0V to 4V, the default value is 0V.</p>

● 18: Maximum charger current setting

Interface	Setting
	<p>Parameter 3: The maximum charging current could be adjusted. Default value is 4A for long run model and 1A for standard model. The available options are 1A, 2A, 4A and 6A. 6A is only available for the UPS with 16 pieces of batteries.</p>

● 19: Battery capacity and groups setting

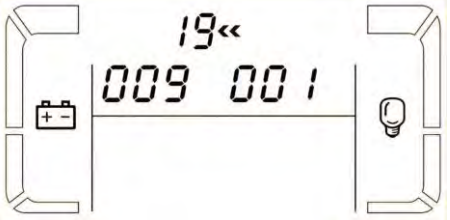
Interface	Setting
	<p>Parameter 2: Set the battery capacity such as 7AH, 9AH, 10AH, 12AH, 17AH, 26AH, 40AH, 65AH, 100AH and so on. The default value is 9AH.</p> <p>Parameter 3: Set battery group range from 1 to 6. The default value is 1 group. These parameters are for the battery backup time calculation.</p>

● 20: Backup time calibration

Interface	Setting
	<p>Parameter 3: Calibrate the displayed backup time by adjusting this multiplier factor. The formulation is listed below: Displayed backup time=Original calculated backup time x Multiplier factor The default value of multiplier factor is 1.0 and the setting range is from 0.5 to 2.</p>

3-7. Operating Mode/Status Description

Operating mode/status		
AC mode	Description	When the input voltage is within acceptable range, UPS will provide pure and stable AC power to output. The UPS will also charge the battery at AC mode.
	LCD display	
CVCF mode	Description	When input frequency is within 46 to 64Hz, the UPS can be set at a constant output frequency, 50 Hz or 60 Hz. The UPS will still charge battery under this mode.
	LCD display	
Battery mode	Description	When the input voltage is beyond the acceptable range or power failure, UPS will backup power from battery and alarm will beep every 4 seconds.
	LCD display	
Bypass mode	Description	When input voltage is within acceptable range and bypass is enabled, turn off the UPS and it will enter Bypass mode. Alarm beeps every two minutes.
	LCD display	
Battery Test	Description	When UPS is in AC mode or CVCF mode, press "Test" key for more than 1s. Then, the UPS will beep once and start "Battery Test". The line between I/P and inverter icons will blink to remind users. This operation is used to check the battery status.

	LCD display		
Fault status	Description	When UPS has fault happened, it will display fault codes in LCD panel.	
	LCD display		

3-8. Fault Code







Fault event	Fault code	Icon	Fault event	Fault code	Icon
Bus start failure	01	None	Low Inverter voltage	13	None
Bus over	02	None	Inverter output short circuited	14	SHORT
Bus under	03	None	Battery SCR short circuited	21	None
Bus unbalance	04	None	Over temperature	41	None
Inverter soft start failure	11	None	Overload	43	OVER LOAD
High Inverter voltage	12	None			

3-9. Warning Indicator

Warning	Icon (flashing)	Alarm
Battery low		Beeping every second
Overload		Beeping twice every second
Battery unconnected		Beeping every second
Over charge		Beeping every second
EPO enable		Beeping every second
Over temperature		Beeping every second
Charger failure		Beeping every second
Overload 3 times in 30min		Beeping every second
Cover of maintain switch is open		Beeping every second

4. Trouble Shooting

If the UPS system does not operate correctly, please solve the problem by using the table below.

Symptom	Possible cause	Remedy
No indication and alarm in the front display panel even though the mains is normal.	The AC input power is not connected well.	Check if input cable firmly connected to the mains.
The icon  and the warning code EP flash on LCD display and alarm beeps every second.	EPO function is enabled.	Set the circuit in closed position to disable EPO function.
The icon  and BATT. FAULT flash on LCD display and alarm beeps every second.	The external or internal battery is incorrectly connected.	Check if all batteries are connected well.
The icon  and OVER LOAD flash on LCD display and alarm beeps twice every second.	UPS is overload.	Remove excess loads from UPS output.
	UPS is overloaded. Devices connected to the UPS are fed directly by the electrical network via the Bypass.	Remove excess loads from UPS output.
	After repetitive overloads, the UPS is locked in the Bypass mode. Connected devices are fed directly by the mains.	Remove excess loads from UPS output first. Then shut down the UPS and restart it.
Fault code is shown as 43. The icon OVER LOAD lights on LCD display and alarm beeps continuously.	UPS is overload too long and becomes fault. Then UPS shut down automatically.	Remove excess loads from UPS output and restart it.
Fault code is shown as 14, the icon SHORT lights on LCD display, and alarm beeps continuously.	The UPS shut down automatically because short circuit occurs on the UPS output.	Check output wiring and if connected devices are in short circuit status.
Other fault codes are shown on LCD display and alarm beeps continuously.	A UPS internal fault has occurred.	Contact your dealer
Battery backup time is shorter than nominal value	Batteries are not fully charged	Charge the batteries at least 7 hours and then check capacity. If the problem still persists, consult your dealer.
	Batteries defect	Contact your dealer to replace the battery.
The icon  and  flash on LCD display and alarm beeps every second.	The UPS temperature is too high.	Check fans and notify dealer.
UPS can not start up, the icon  flashes on LCD display, and alarm beeps every second.	Cover of maintain switch is open.	Check if the cover of maintain switch is screwed tightly.

5. Storage and Maintenance

5-1. Storage

Before storing, charge the UPS at least 7 hours. Store the UPS covered and upright in a cool, dry location. During storage, recharge the battery in accordance with the following table:

Storage Temperature	Recharge Frequency	Charging Duration
-25°C - 40°C	Every 3 months	1-2 hours
40°C - 45°C	Every 2 months	1-2 hours

5-2. Maintenance



The UPS system operates with hazardous voltages. Repairs may be carried out only by qualified maintenance personnel.



Even after the unit is disconnected from the mains, components inside the UPS system are still connected to the battery packs which are potentially dangerous.



Before carrying out any kind of service and/or maintenance, disconnect the batteries and verify that no current is present and no hazardous voltage exists in the terminals of high capability capacitor such as BUS-capacitors.



Only persons are adequately familiar with batteries and with the required precautionary measures may replace batteries and supervise operations. Unauthorized persons must be kept well away from the batteries.



Verify that no voltage between the battery terminals and the ground is present before maintenance or repair. In this product, the battery circuit is not isolated from the input voltage. Hazardous voltages may occur between the battery terminals and the ground.



Batteries may cause electric shock and have a high short-circuit current. Please remove all wristwatches, rings and other metal personal objects before maintenance or repair, and only use tools with insulated grips and handles for maintaining or repairing.



When replace the batteries, install the same number and same type of batteries.



Do not attempt to dispose of batteries by burning them. This could cause battery explosion. The batteries must be rightly deposited according to local regulation.



Do not open or destroy batteries. Escaping electrolyte can cause injury to the skin and eyes. It may be toxic.



Please replace the fuse only with the same type and amperage in order to avoid fire hazards.



Do not disassemble the UPS system.

6. Specifications

Tower UPS

MODEL		6K		10K	
CAPACITY*		6000 VA / 5400 W		10000 VA / 9000 W	
INPUT					
Voltage Range	Low Line Loss	110 VAC ± 3 % at 50% Load; 176 VAC ± 3 % at 100% Load			
	Low Line Comeback	Low Line Loss Voltage + 10V			
	High Line Loss	300 VAC ± 3 %			
	High Line Comeback	High Line Loss Voltage - 10V			
Frequency Range		46Hz ~ 54 Hz @ 50Hz system 56Hz ~ 64 Hz @ 60Hz system			
Phase		Single phase with ground			
Power Factor		≥ 0.99 at 100% Load			
OUTPUT					
Output voltage		208/220/230/240VAC			
AC Voltage Regulation		± 1%			
Frequency Range (Synchronized Range)		46Hz ~ 54 Hz @ 50Hz system 56Hz ~ 64 Hz @ 60Hz system			
Frequency Range (Batt. Mode)		50 Hz ± 0.1 Hz or 60Hz ± 0.1 Hz			
Overload	AC mode	100%~110%: 30min; 110%~130%: 5min; >130% : 10sec			
	Battery mode	100%~110%: 3min; 110%~130%: 30sec; >130% : 10sec			
Current Crest Ratio		3:1 max			
Harmonic Distortion		≤ 3 % THD (Linear Load) ≤ 5 % THD (Non-linear Load)			
Transfer Time	Line ↔ Battery	0 ms			
	Inverter ↔ Bypass	0 ms			
EFFICIENCY					
AC mode		> 92%		> 93%	
Battery Mode		> 90%		> 91%	
BATTERY					
Standard Model	Battery Type	12 V / 9 Ah			
	Numbers	16	20	16	20
	Recharge Time	9 hours recover to 90% capacity			
	Charging Current	Default : 1 A ± 10% Max.: 1A, 2A (Adjustable)			
Charging Voltage		218.4V ± 1%	273V ± 1%	218.4V ± 1%	273V ± 1%
Long-run Model	Battery Type	Depending on applications			
	Numbers	16-20			
	Charging Current	Default: 4 A ± 10% Max.: 1A, 2A, 4A, 6A (Adjustable, 6A is only available for 16pcs batteries)			
	Charging Voltage		218.4V ± 1% (based on 16pcs batteries)		
PHYSICAL					
Standard Model	Dimension,DXWXH(mm)	369 x 190 x 688	442x 190 x 688		
	Net Weight (kgs)	61	74	66	76
Long-run Model	Dimension, DXWXH(mm)	369 x 190 x 318		442x 190 x 318	
	Net Weight (kgs)	12		16	
ENVIRONMENT					
Operation Temperature		0 ~ 40°C (battery life cycle will be shorten when temperature is above 25°C)			
Operation Humidity		<95 % and non-condensing			
Operation Altitude**		<1000m			
Acoustic Noise Level		Less than 55dB @ 1 Meter		Less than 58dB @ 1 Meter	
MANAGEMENT					
Smart RS-232 or USB		Supports Windows® 2000/2003/XP/Vista/2008, Windows® 7/8, Linux, Unix, and MAC			
Optional SNMP		Power management from SNMP manager and web browser			

* Derate capacity to 60% of capacity in CVCF mode and to 90% when the output voltage is adjusted to 208VAC.

** If the UPS is installed or used in a place where the altitude is above than 1000m, the output power must be derated one percent per 100m.

***Product specifications are subject to change without further notice.

Rack UPS

MODEL		6KR		10KR	
CAPACITY*		6000 VA / 5400 W		10000 VA / 9000 W	
INPUT					
Voltage Range	Low Line Loss	110 VAC ± 3 % at 50% Load; 176 VAC ± 3 % at 100% Load			
	Low Line Comeback	Low Line Loss Voltage + 10V			
	High Line Loss	300 VAC ± 3 %			
	High Line Comeback	High Line Loss Voltage - 10V			
Frequency Range		46Hz ~ 54 Hz @ 50Hz system 56Hz ~ 64 Hz @ 60Hz system			
Phase		Single phase with ground			
Power Factor		≥ 0.99 at 100% Load			
OUTPUT					
Output voltage		208/220/230/240VAC			
AC Voltage Regulation		± 1%			
Frequency Range (Synchronized Range)		46Hz ~ 54 Hz @ 50Hz system 56Hz ~ 64 Hz @ 60Hz system			
Frequency Range (Batt. Mode)		50 Hz ± 0.1 Hz or 60Hz ± 0.1 Hz			
Overload	AC mode	100%~110%: 30min; 110%~130%: 5min; >130% : 10sec			
	Battery mode	100%~110%: 3min; 110%~130%: 30sec; >130% : 10sec			
Current Crest Ratio		3:1 max			
Harmonic Distortion		≤ 3 % THD (Linear Load) ≤ 5 % THD (Non-linear Load)			
Transfer Time	Line↔Battery	0 ms			
	Inverter↔Bypass	0 ms			
EFFICIENCY					
AC mode		> 92%		> 93%	
Battery Mode		> 90%		> 91%	
BATTERY					
Standard Model	Type & Numbers	12 V / 9 Ah x 16	12V / 9 Ah x 20	12 V / 9 Ah x 16	12V / 9 Ah x 20
	Recharge Time	9 hours recover to 90% capacity			
	Charging Current	Default : 1 A ± 10% Max.: 1A, 2A (Adjustable)			
	Charging Voltage	218.4V ± 1%	273V ± 1%	218.4V ± 1%	273V ± 1%
Long-run Model	Type	Depending on applications			
	Numbers	16 – 20 (Adjustable)			
	Charging Current	Default: 4 A ± 10% Max.: 1A, 2A, 4A, 6A (Adjustable, 6A is only available for 16pcs batteries)			
	Charging Voltage	218.4V ± 1% (Based on 16pcs batteries)			
PHYSICAL					
Standard Model	Dimension, DXWXH(mm)	UPS unit: 530 x 438 x 88 [2U] Battery pack: 668 x 438 x 88 [2U]	UPS unit: 530 x 438 x 88 [2U] Battery pack: 580 x 438 x 133 [3U]	UPS unit: 580 x 438 x 133 [3U] Battery pack: 580 x 438 x 133 [3U]	UPS unit: 580 x 438 x 133 [3U] Battery pack: 580 x 438 x 133 [3U]
	Net Weight (kgs)	UPS unit: 15 Battery pack: 48	UPS unit: 15 Battery pack: 61	UPS unit: 18 Battery pack: 51	UPS unit: 18 Battery pack: 61
Long-run Model	Dimension, DXWXH(mm)	530 x 438 x 88 [2U]		580 x 438 x 133 [3U]	
	Net Weight (kgs)	15		18	
ENVIRONMENT					
Operation Temperature		0 ~ 40°C (battery life cycle will be shorten when temperature is above 25°C)			
Operation Humidity		<95 % and non-condensing			
Operation Altitude**		<1000m			
Acoustic Noise Level		Less than 55dB @ 1 Meter		Less than 58dB @ 1 Meter	
MANAGEMENT					
Smart RS-232 or USB		Supports Windows® 2000/2003/XP/Vista/2008, Windows® 7/8, Linux, Unix, and MAC			
Optional SNMP		Power management from SNMP manager and web browser			

* Derate capacity to 60% of capacity in CVCF mode and to 90% when the output voltage is adjusted to 208VAC.

** If the UPS is installed or used in a place where the altitude is above than 1000m, the output power must be derated one percent per 100m.

***Product specifications are subject to change without further notice.