



# **DS300HT SERIES**

**DSP Controlled UPS**

**200-250-300-400-500 kVA**

**3 Phase In - 3 Phase Out**

**USER MANUAL**



# CONTENTS

<b>I. GENERAL DESCRIPTION .....</b>	<b>3</b>
1.1 Introduction .....	3
1.2 Design Concept.....	5
1.2.1 Description of Blocks.....	6
1.2.2 Operating conditions of ups.....	6
1.3 Front view of UPS Connection Panel .....	7
1.4 Technical Specifications.....	9
<b>II. UPS INSTALLATION .....</b>	<b>10</b>
2.1. Introduction .....	10
2.2. Unpacking .....	10
2.3. Equipment Positioning.....	10
2.4. Connecting the UPS Power Cables.....	11
2.5. Safety Earth .....	11
2.6. Cable Connection Procedure .....	11
2.6.1. UPS Power Cable Connection Terminals .....	12
2.7. Battery Installation.....	13
<b>III. FRONT PANEL .....</b>	<b>14</b>
3.1. Introduction .....	14
3.2. Front Panel Menu Descriptions .....	14
3.2.1 MEASUREMENTS menu .....	17
3.2.2 ALARM LOGS menu .....	18
3.2.3 INFORMATION menu .....	18
3.2.4 OPTIONS menu .....	19
3.2.5 COMMAND menu .....	21
3.2.6 TIME menu.....	21
3.2.7 SERVICE menu.....	21
3.2.8 ADJUST menu .....	22
3.2.9 User Pasword.....	22
3.3. Alarms and warning messages .....	22
3.4. Status Codes .....	25
3.5. Alarm messages and quick troubleshooting .....	31

---



---

<b>IV. OPERATING INSTRUCTIONS .....</b>	<b>36</b>
4.1 Introduction .....	36
4.2 Operating ups in online mode.....	36
4.2.1 Starting ups from a completely shut down position.....	36
4.2.2 Shutting down the ups .....	36
4.2.3 Switching the UPS from a normal operation to maintenance bypass condition .....	37
4.2.4 Switching the UPS from a maintenance bypass condition to normal operation.....	37
4.3 UPS Behavior During mains outage .....	38
<b>V. PARALLEL OPERATION.....</b>	<b>39</b>
5.1 Introduction.....	39
5.2 Parallel Operation Mode settings of DS300HT Series UPSs.....	40
5.3 Parallel mode status codes of the UPS.....	43
<b>VI. PARALLEL OPERATING INSTRUCTIONS.....</b>	<b>48</b>
6.1 INTRODUCTION.....	48
6.2 OPERATING INSTRUCTIONS FOR PARALLEL CONNECTED UPSs.....	48
6.2.1 Starting UPSs from a completely shut down position.....	48
6.2.2 Shutting down the UPS.....	48
6.2.3 Switching the UPS from a Normal Operation to Maintenance Bypass Condition.....	49
6.2.4 Switching the UPS from a Maintenance Bypass Condition to Normal Operation.....	49
<b>VII. MAINTENANCE.....</b>	<b>50</b>
7.1 Scheduled maintenance .....	50
7.2 Daily checks .....	50
7.3 Weekly checks.....	50
7.4 Annual Maintenance.....	51
7.5 Storage conditions and transportation of ups.....	51
<b>VIII. FAULTS AND TROUBLESHOOTING .....</b>	<b>52</b>
8.1 General Procedure for fault checking and troubleshooting.....	52
8.2 Before calling service.....	52
<b>IX. UPS REMOTE MANITORING AND CONTROL.....</b>	<b>53</b>
9.1 Using Serial Port.....	53
9.2 Serial Communication port connection cable .....	53
9.3 Modem connection .....	54
9.3.1 Hardware configuration .....	54
9.3.2 Functioning Principle .....	54
9.3.3 Modem Programming Procedure .....	54
9.3.3.1 Smart modem (SM) programming .....	54
9.3.4 Modem – UPS Connection Cable.....	55
9.4 Dry contact (interface) connections .....	55
9.5 Remote monitoring panel connection of UPS.....	55
<b>X. EFFICIENT USAGE OF UPS IN TERMS OF ENERGY CONSUMPTION.....</b>	<b>56</b>

---



---

---

---

## SAFETY

### IMPORTANT NOTICES

1. Read instructions carefully before installing and starting the UPS.
2. All warnings in the manual should be adhered to.
3. All operating instructions should be followed.
4. The unit should be supplied by a grounded outlet. Do not operate the unit without a ground source.
5. Power cables of the UPS should be routed carefully so that they are not to be walked on.
6. Please save this manual.
7. Please save or recycle the packaging materials.

### WARNING!

- Do not insert any object into ventilation holes or other openings.
- To reduce the risk of fire or electric shock, install in temperature and humidity controlled indoor area free of conductive contaminants.
- To reduce the risk of fire, replace fuses with the same type and rating when necessary.

### CAUTION!

- **Only qualified personnel should install or service UPS/batteries.**
- **Risk of electric shock, do not remove cover. No user serviceable parts inside, refer servicing to qualified service personnel.**
- The output may be energized even when the unit is not connected to a mains supply.
- **Risk of electric shock! Hazardous live parts inside. This unit is energized from the battery supply even when the input AC power is disconnected.**
- To reduce the risk of electric shock, disconnect the UPS from the mains supply before installing a computer interface signal cable. Reconnect the power cables only after signaling interconnections have been made.

### CAUTION !

**Units are designed to operate on the concrete floor.**

### ABOUT THE BATTERIES

#### **CAUTION: RISK OF ELECTRIC SHOCK!**

**The battery circuit is not isolated from the mains voltage. Hazardous voltages may occur between the battery terminals and the ground!**

- A battery can present a risk of electric shock or burn from high short circuit currents. The following precautions should be taken when working on batteries :
  - \* Remove watches, rings or other metal objects.
  - \* Use tools with insulated handles.
- The batteries in this UPS are recyclable. Batteries must be disposed of according to local environmental laws. The batteries contain lead and pose a hazard to the environment and human health if not disposed of properly.
- Do not dispose of batteries in a fire. The batteries may explode. Do not open or mutilate the batteries. They contain an electrolyte which is toxic and harmful to the skin and eyes. If electrolyte comes into contact with the skin the affected area should be washed immediately.
- The internal energy source (the battery) cannot be de-energized by the user.
- When changing batteries, install the same number and same type of batteries.

---

---

## I. GENERAL DESCRIPTION

### 1.1 Introduction

TESCOM DS300HT Series Uninterruptible Power Supplies are double-conversion; on-line UPS's manufactured with the latest IGBT and PWM technology, to produce an uninterruptible, **fully DSP (Digital Signal Processor) controlled** pure sine wave output to critical loads.

TESCOM DS300HT Series units are 3-phase in/3-phase out devices, and they are installed between a three phase critical load, and a 3-phase+N mains supply

The advantages of using DS300HT UPS:

- *Power blackout protection:*

If the mains power fails, the UPS continues to supply the critical load using the energy stored in its batteries, keeping the load immune from power disturbances.

- *Increased power quality:*

The UPS has its own internal voltage and frequency regulating software, which ensures that, its output to the critical load is maintained within close tolerances, independent of voltage and frequency variations on the mains power lines.

- *Fully digital control by three DSP controller for each UPS:*

The UPS is controlled by 3 independent DSP chips which are communicating each other continuously. Rectifier, Inverter and User Interface modules have separate DSP's to achieve the highest performance. Each DSP module has many parameters to control and monitor the system to have the best electrical power output and to help diagnostic.

- *Increased noise rejection:*

By rectifying the input AC power to DC power and then converting it back to AC (Double-Conversion) any electrical noise present on the input mains supply line is effectively isolated from the UPS output. Therefore the critical load is supplied with only clean and uninterrupted AC power.

---

---

## **Basic Features:**

- PWM and IGBT technology
- Three level technology
- Pure sinusoidal output wave form and true on-line topology
- High input power factor (IGBT rectifier), Input current limiting
- Low input current THD (IGBT rectifier)
- Low output voltage THD
- High AC/AC and DC/AC efficiency (up to 94%)
- 3 separate DSP (Digital Signal Processor) control
- Cold-start feature
- Static By-Pass feature: Provides uninterruptable transfer to bypass source in case of overload or UPS fault.
- Bypass leakage current sense system
- Maintenance bypass switch and warning system, by-pass short circuit protection
- Separate bypass input facility (split bypass), generator operation sense input
- LCD alphanumeric display panel providing battery, load, voltage, power and status information in detail to user
- Improved diagnostics and correct fault information
- Up to 192 event memory record system (7000 alarms or warnings total)
- Real time clock and calendar system
- Overload operation 10 minutes at 100% - 125% load, 1 minute at 125% - 150% load
- Output overload, over-current and short circuit protection, output current limiting
- Reliable operation at even 100% unbalanced load condition
- Non-linear load supply feature (CF 3:1)
- Double polarity battery (with common terminal)
- Automatic and manual battery test and battery temperature compensation features
- 3 separate maintenance clock counters
- Battery charge with current limiting
- Automatic and manual boost charge feature
- Battery deep discharge protection
- Temperature protection with 3 separate sensors
- Interactive communication
- Diagnostic and settings with PC ability
- 2 separate RS232 communication ports (standard)
- Multi UPS monitoring on same communication line by RS485 (optional)
- 4 dry contact alarm relay outputs as standard (8 optional relay outputs)
- Improved remote monitoring panel system (optional)
- RS232 port multiplexer (optional)
- Direct network connection with optional SNMP support
- MODBUS Adapter (optional)
- AT command set definitions for dumb modems
- Communication via Windows based T-MON software and remote monitoring and control of UPS via modem
- Optional softwares compatible for most computer platforms
- Ability for labeling of UPSs by users
- Emergency power-off support
- Conformity to international and local standards
- AC input and output filters
- Optional graphic front panel
- CE compliance
- Input, bypass and load phase order protection
- Optional leakage current alarm system
- Input and output isolation transformers (optional)
- Enhanced accessory options
- 100.000 hours MTBF
- 2 years system warranty
- 10 years spare parts warranty

## 1.2 Design Concept

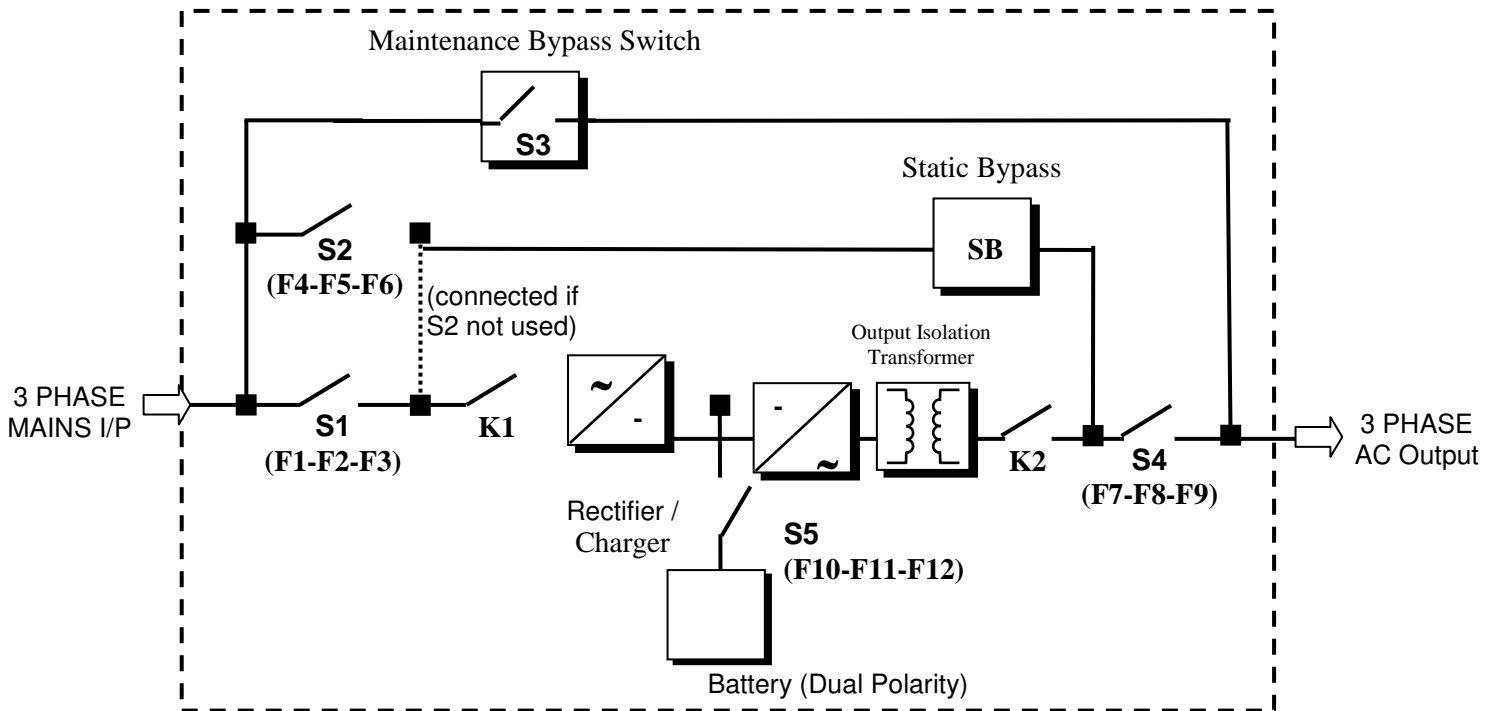

- S1 (F1-F2-F3)** : Rectifier Input Switch / Fuse
- S2 (F4-F5-F6)** : Bypass Input Switch / Fuse
- S3** : Maintenance Bypass Switch
- S4 (F7-F8-F9)** : Output Switch / Fuse
- S5 (F10-F11-F12)** : Battery Switch / Fuse
- K1** : Rectifier Input Contactor
- K2** : Inverter Output Contactor



---

---

### **1.2.1 DESCRIPTION OF BLOCKS**

**RECTIFIER:** In DS300HT Series UPSs, a DSP controlled IGBT rectifier with PWM technique is used to increase input power factor (PFC) and to decrease input current harmonics (THDI).

The IGBT rectifier accepts 3-phase AC input and produces a dual polarity DC voltage for both supplying the inverter and charging the batteries.

**BATTERIES:** Batteries are used as reserve DC power supply for the Inverter in case of mains failure. In DS300HT Series, batteries are connected in series with a center-tap output to obtain a dual polarity DC supply.

Batteries are discharged by the inverter during mains failure. The discharged batteries are re-charged by the IGBT Rectifier on a constant voltage / current limiting basis, if AC mains power is available.

**INVERTER:** It is manufactured by using the latest IGBT and DSP (Digital Signal Processing) technologies, and Pulse Width Modulation (PWM) technique. The Inverter converts the DC BUS voltage supplied by the IGBT Rectifier and / or the batteries into a well regulated, fully digital controlled 3-phase AC voltage with fixed voltage and frequency.

The output of the inverter is used to supply the critical loads connected to the UPS output.

**STATIC TRANSFER SWITCH (STATIC BYPASS):** This is an electronically controlled transfer switch, which enables the critical load to be connected either to inverter output or to by-pass power source. During normal operation, the load is supplied by the inverter output, but in case of an overload or a UPS failure it is automatically transferred to the bypass source without any interruption.

**MAINTENANCE BYPASS SWITCH (MBS):** This is a manually controlled mechanical switch, which is used to supply the critical load, using the bypass source, when the UPS is shut down for maintenance or troubleshooting purposes.

The load is unprotected against mains supply disturbances and black-outs when it is connected to either static or maintenance bypass supply.

### **1.2.2. OPERATING CONDITIONS OF UPS**

UPS may be in one of the following operating conditions:

#### **A. Normal Operation (If Mains supply is available):**

All fuses and power switches are closed (except the Maintenance Bypass Switch), and the load is supplied by the Inverter Output. During normal operation, the Rectifier supplies DC power to the Inverter and charges the Batteries at the same time.

#### **B. Battery Operation :**

The Batteries are connected to the Rectifier output. In case of a mains failure (mains power outage or AC input voltage out of tolerance), the Rectifier stops operating and the DC voltage necessary for the inverter operation is supplied by the batteries. Therefore the AC voltage output supplying the critical load is not interrupted, until the batteries are fully discharged. At the end of the discharging time the inverter is turned off and it start again automatically, together with the rectifier, when the mains power is restored, and the UPS returns o normal operation. For UPS with a split bypass source, at the end of discharging time, static transfer switch transfers the load to the split bypass source without interruption if the split bypass source is available and in acceptable tolerances about voltage and frequency, as still the rectifier input is not available.

The Rectifier is also turned off and inverter operates on batteries during automatic or manual battery test procedure.

#### **C. By-Pass Operation :**

If the Inverter output is overloaded or in case of a problem in the UPS, the static switch transfers the load to the bypass supply without any interruption, provided that the bypass supply is available and within the tolerated limits regarding voltage and frequency. At the end of the overloading period, if the fault condition is restored, static switch transfers the critical load again to the inverter output. Note that, during operation from the bypass supply, the critical load may be effected by any possible disturbances or power failure in the bypass supply.

### 1.3 Front view of UPS Connection Panel

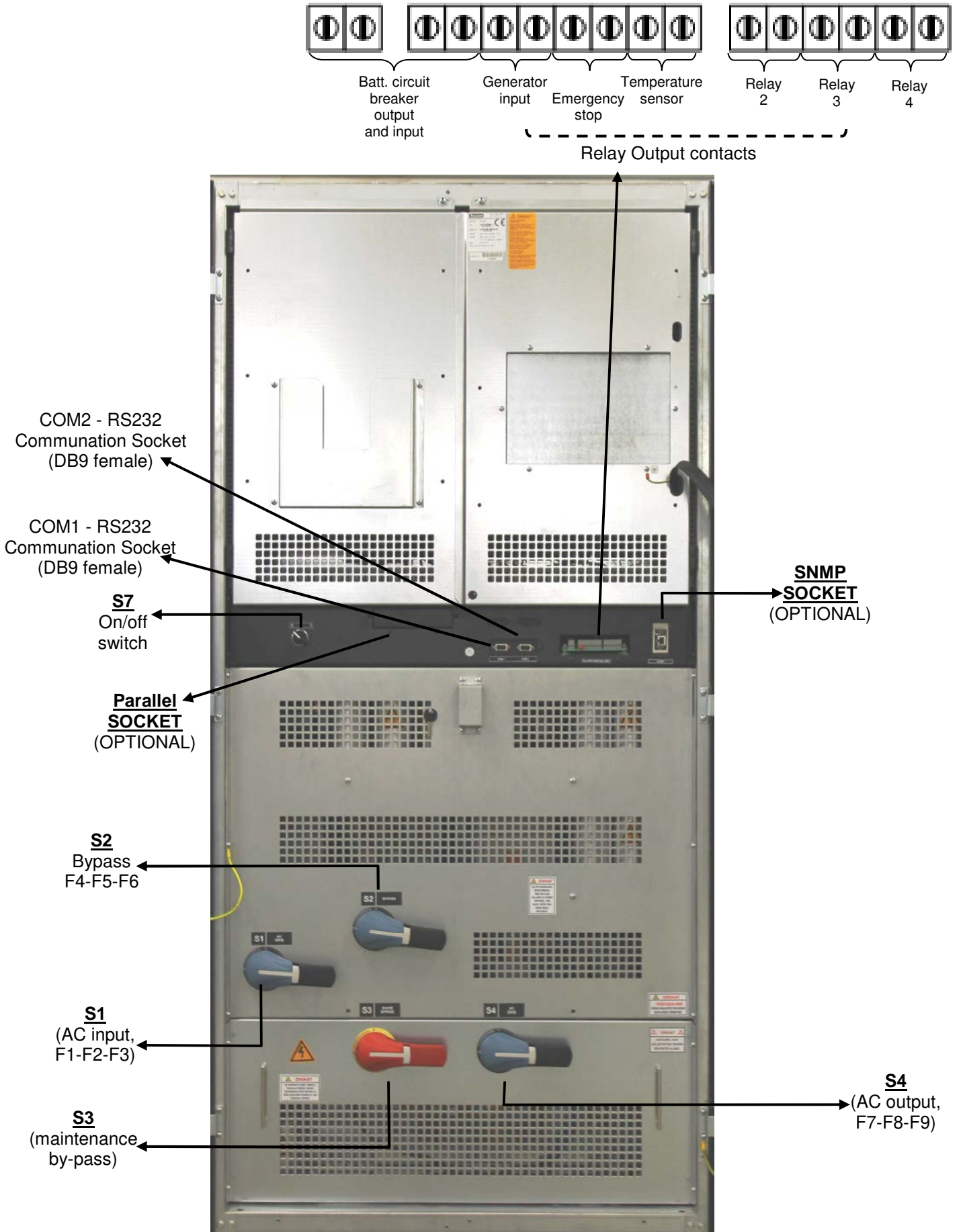

Figure 1.3 a 200-250 kVA Switches, Fuses and Interface Connections

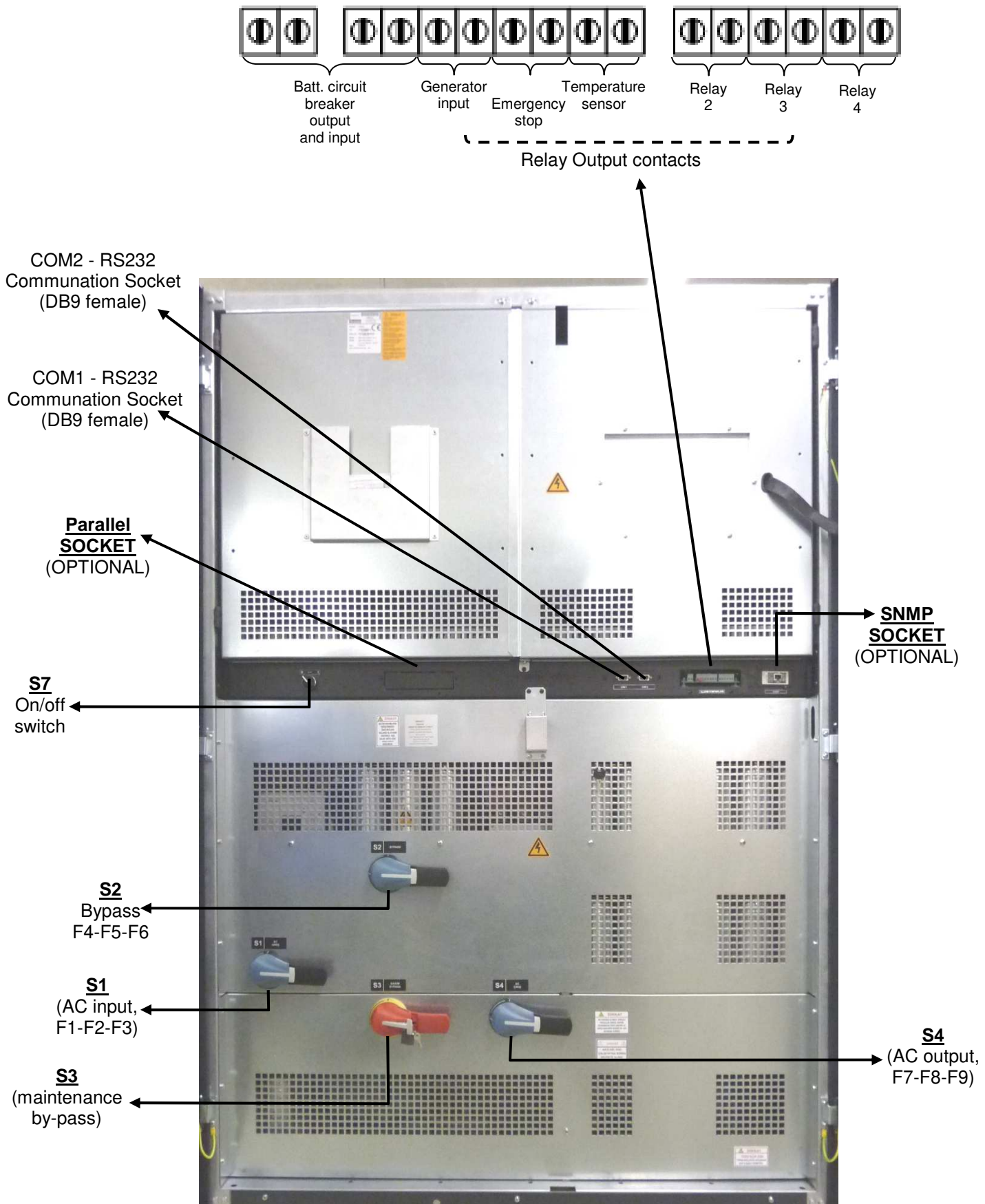

Figure 1.3 b 300-400-500 kVA Switches, Fuses and Interface Connections

## 1.4 Technical Specifications

MODEL	DS3200HT	DS3250HT	DS3300HT	DS3400HT	DS3500HT
Output (KVA)	200 kVA	250 kVA	300 kVA	400 kVA	500 kVA
Output (KW)	180 kW	225 kW	270 kW	360 kW	400 kW
Output Power Factor	0,9				0,8
<b>INPUT</b>					
Number of Phases	3 Phase + Neutral				
Input Voltage	220/380, 230/400 or 240/415 Vac				
Input Voltage Tolerance	+20% , -25% (+15% at 240/415Vac)				
Input Power Factor (PF)	0,98 - 0,99 (at full load)				
Input THDI	<= 5% (at full load)				
Input Frequency	50/60 Hz. ±10%				
By-pass Voltage	220/380, 230/400 or 240/415 Vac 3 Phase + Neutral				
By-pass Frequency	50 Hz. ±2%				
RFI Level	EN62040-2				
<b>OUTPUT</b>					
Number of Phases	3 Phase + Neutral				
Output Voltage	220/380, 230/400 or 240/415 Vac				
Output Voltage Tolerance	±1%				
Output Frequency	50/60 Hz				
Output Frequency Tolerance (Synchronous)	±2%				
Output Frequency Tolerance (Battery)	±0,1% (free/battery operation mode)				
Efficiency (100% Load)	up to 94%				
Load Crest Factor	3:1				
Output Voltage THD (linear load)	<=2%				
Overload	125% Load 10min. , 150% Load 1min.				
<b>BATTERY</b>					
Total Number	56 blocks 12V (2x28 serial 56 batteries, external)				
Float Charge Voltage (25°C)	± 378V DC				
End of Discharge Voltage	± 280V DC				
Battery Test	Automatic and Manual				
Boost Charge	Available				
<b>COMMUNICATION INTERFACES</b>					
RS232 Com Port	2 each standard (COM1 and COM2)				
External Temperature Measurement Input	Available (standard)				
RS485 Comm. Port	Optional				
Remote Monitoring Panel	Optional				
SNMP Adapter	Optional				
Modbus Adapter	Optional				
Alarm Relay Contacts	4 each dry contacts (function programmable) 8 optional				
Digital Inputs	2 each optional				
Emergency Power-Off Input	Available (standard)				
<b>ENVIRONMENT</b>					
Operating Temperature	0 – 40°C				
Operating Humidity	<= %90 (non-condensing)				
Acoustic Noise	< 68 dB				
Dimensions (WxDxH) (mm)	880x775x1900	1245x775x1900		1250 x 840 x 2040+ Transfor mer cabinet	
Device Type and Protection Class	Class 1 – IP20				

---

---

## II. UPS INSTALLATION

### 2.1 Introduction

#### **WARNING!!!**

- Do not apply electrical power to the UPS equipment before the arrival of authorized service personnel.
- The UPS equipment should be installed only by qualified service personnel.
- The connection of the batteries and the maintenance should be done by qualified service personnel.
- Do not make any short-circuit to the battery poles. Because of high voltage and high short-circuit current, there is risk of electrical shock or burn.
- Eye protection should be worn to prevent injury from accidental electrical arcs. Remove rings, watches and all metal objects. Only use tools with insulated handles. Wear rubber gloves.

This chapter contains location installation information of the UPS and the batteries. All the establishments have their own specialties and needs. So in this part, the installation procedure is not being explained step by step. Instead, general procedure and the applications are explained for the technical personnel.

### 2.2 Unpacking

The UPS is packed and enclosed in a structural cardboard carton to protect it from damage.

- 1) Inspect for damage that may have occurred during the shipment. If any damage is noted, call the shipper immediately and retain the shipping carton and the UPS.
- 2) Carefully open the carton and take the UPS out.
- 3) Retain the carton and packing material for future use.

Unit package contents:

- 1) A user manual and Guarantee certificate.
- 2) Battery cabinet and/or shelf (Optional)
- 3) Battery connection cables.

### 2.3 Equipment Positioning

**ATTENTION: Units are designed to operate on the concrete floor.**

1. The equipment's installation place must be an easy serving place.
2. Install the UPS in a protected area with adequate air flow and free of excessive dust.
3. You must therefore allow for a minimum gap of 200 mm behind the unit to allow adequate air flow.
4. Select a suitable place (temperature between 0°C and 40°C) and the relative humidity (%90 max)
5. It is recommended to place the equipment in an air-conditioned room (24°C)
6. Temperature is a major factor in determining the battery life and capacity. Keep batteries away from main heat sources or main air inlets etc.
7. In case of an operating the UPS in a dusty place, clean the air with a suitable air filtration system.
8. Keep out of your equipment from explosive and flammable items.
9. Avoid direct sunlight, rain, and high humidity.

**WARNING!!!** Check the capacity of the forklift if it is available for lifting.

**DO NOT LEAN OR LIFT THE BATTERY CABINET(S) AFTER THE BATTERIES HAVE BEEN INSTALLED.**



## 2.4 Connecting the UPS Power Cables

**WARNING!!!** A separate power line should be used to supply the UPS AC input. Never use the same line to supply another electrical device. Do not use any additional cable to increase the length of the UPS's input cable. It is advised to use an MCCB suitable for the input current on the UPS's input line.

**The connection of the electrical panel should be supplied by a grounded outlet.** Otherwise, the UPS and the load connected to the output will be left ungrounded. The grounding system must be checked, and must be strengthened if required. Potential difference between ground and neutral must be less than 3V AC.

Descriptions of the UPS input output cable connection terminals are shown in figure 2.2

Recommended input line cable and fuse ratings are given in the table below.

UPS power (kVA)	Recommended cable size (mm <sup>2</sup> )			Input / output Cable connections U-V-W-N	Battery connections + & -	INPUT Fuses	Output/Bypass Fuses	Battery Fuses
	Line input	Bypass input / UPS output	External Battery					
200	95	70	70	M10 bolt	M10 bolt	315A	315A	400A
250	120	95	95	M10 bolt	M10 bolt	400A	315A	400A
300	150	120	120	M10 bolt	M10 bolt	500A	500A	550A
400	185	150	150	M10 bolt	M10 bolt	630A	630A	630A
500	185	150	150	M10 bolt	M10 bolt	800A	800A	800A

**NOTES:** The neutral conductor should be sized for 1,5 times the output/bypass phase current. These recommendations are for guideline purposes only and are superseded by local regulations and codes of practice.

## 2.5 Safety Earth

The safety earth cable must be connected to the earth BUS BAR and bonded to each cabinet in the system and also the earthing and neutral bonding arrangements must be in accordance with the local laws.

**ATTENTION!!!** Failure to follow adequate earthing procedures can result in electric shock hazard to personnel, or the risk of fire.

## 2.6 Cable connection procedure

**WARNING!!!** All connections of the UPS must be done by qualified service personnel

After positioning the UPS, the cables must be connected as described below:

1. Verify all switches and fuses in front of the UPS are at "0" position. (OFF)
2. Connect the 3 phase AC input coming from the mains distribution panel to the AC input terminals as shown on the label. (Figure 2.2)

**ATTENTION!!!: ENSURE CORRECT PHASE SEQUENCE.**

If there is a phase sequence error, UPS doesn't transfer the load to INVERTER output. If you can't see SYNC:OK in the INFORMATION MENU on LCD, then change the input phase sequence.

3. Connect the output of the UPS to the load distribution panel.
4. Connect the battery groups. Refer to battery installation section.

**WARNING :**

- CHECK BOTH OF THE BATTERY GROUPS FOR CORRECT POLARITY AND VOLTAGE
- DO NOT TURN ON THE BATTERY SWITCH (F5) BEFORE STARTING THE UPS

5. Connect the copper earth bus, to the safety earth of the mains distribution panel.

**NOTE :** The earth and the neutral connections must be in accordance with the local rules.

**WARNING:** Note that the Input Neutral (N1) **MUST** also be connected to K10 terminal

**2.6.1 UPS Power Cable Connection Terminals :**

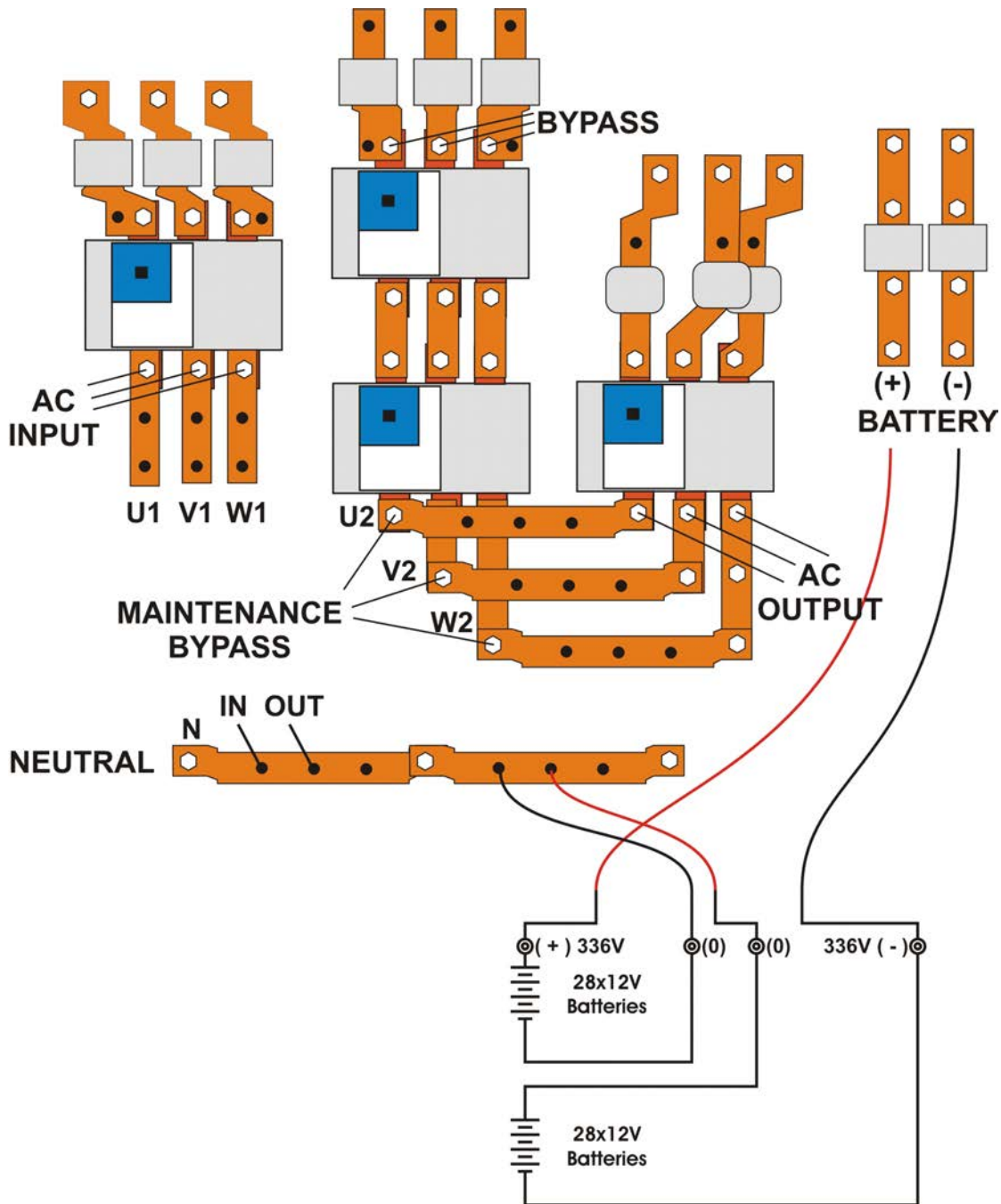

**Figure 2.2** 200 - 250 - 300 – 400-500 kVA POWER Cable

---

---

## **NOTES :**

- As shown on the power cable connection diagram of the UPS, U1, V1 and W1 phase of the incoming 3 phase supply are used as the bypass inputs under normal conditions, if there is not a separate bypass supply (split bypass). (U1, V1, W1 and U2, V2, W2 are the same in this case)
- If there is a separate 3- phase AC supply for bypass (Split Bypass):

a-) Remove the links between K4-K5, K6-K7, and K8-K9

b-) Connect the phases of the bypass source U2, V2 and W2 to the indicated terminals (K5,K7,K9)

c-) Connect the Neutral (N2) of the Bypass source to K11. (Neutral Busbar)

**Note that the Neutral of the 3 phase input supply (N1) and the Neutral of the 3-phase bypass supply (N2) must always be connected together to form the Neutral of the AC output.**

## **2.7 Battery Installation**

**WARNING!!! Be careful while connecting batteries.**

**ATTENTION!!!** Open the battery switch/fuse before making any connection on the batteries.

The batteries associated with the UPS equipment are usually contained in a purpose-built battery cabinet. External batteries are used in DS300HT Series 200,250,300,400 and 500 kVA UPSs, there is no space for internal batteries in UPS cabinet.

Where battery racks are used, they should be sited and assembled in accordance with the battery manufacturer's recommendations. In general, batteries require a well-ventilated, clean and dry environment at reasonable temperatures to obtain efficient battery operation.

In general a minimum space of 10 mm must be left on all vertical sides of the battery block. A minimum clearance of 20 mm should be allowed between the cell surface and any walls. All metal racks and cabinets must be earthed.

1. Unpack each battery and check its terminal voltage with a suitable load. Any battery with terminal voltage less than 10,5V must be charged before installation.
2. Please check the battery connecting hardware and documents. (cables, trays, connection diagrams)
3. Please locate suitable number of batteries on each rack, according to the battery installation and connection diagram given with the unit.
4. Start locating the batteries from top to the bottom on the racks.
5. Be careful about the connection between the racks and polarities.
6. After interconnecting the batteries, connect "+", "0" and "-" leads of the batteries to the battery input terminals on the UPS. Be careful to connect the batteries correctly and do not turn on (S5) before checking all connections and before starting the UPS. In DS300HT Series UPS, 56 blocks of batteries are connected in series, in such a way that they form two strings of batteries with opposite polarity; with a center tap connection to the NEUTRAL (N1-N2) internally.

**NOTE THAT SEPARATE CABLES FROM EACH BATTERY GROUP SHOULD BE CONNECTED TO K2 TERMINALS TO FORM THE MIDPOINT CONNECTION.**

**WARNING!!! NEVER TURN ON S5 (BATTERY SWITCH) (OR CONNECT BATTERY FUSES F10, F12) WITHOUT CENTER POINT CONNECTION TO K2.**



## III. FRONT PANEL

### 3.1 Input

The front panel of UPS, consisting of a 4 lines alphanumeric display, 7 status lamps, plus 5 function keys, allows the complete monitoring of the UPS status. The mimic flow diagram helps to comprehend the operating status of the UPS. By using the function keys operator can moves on menus and change some parameters.

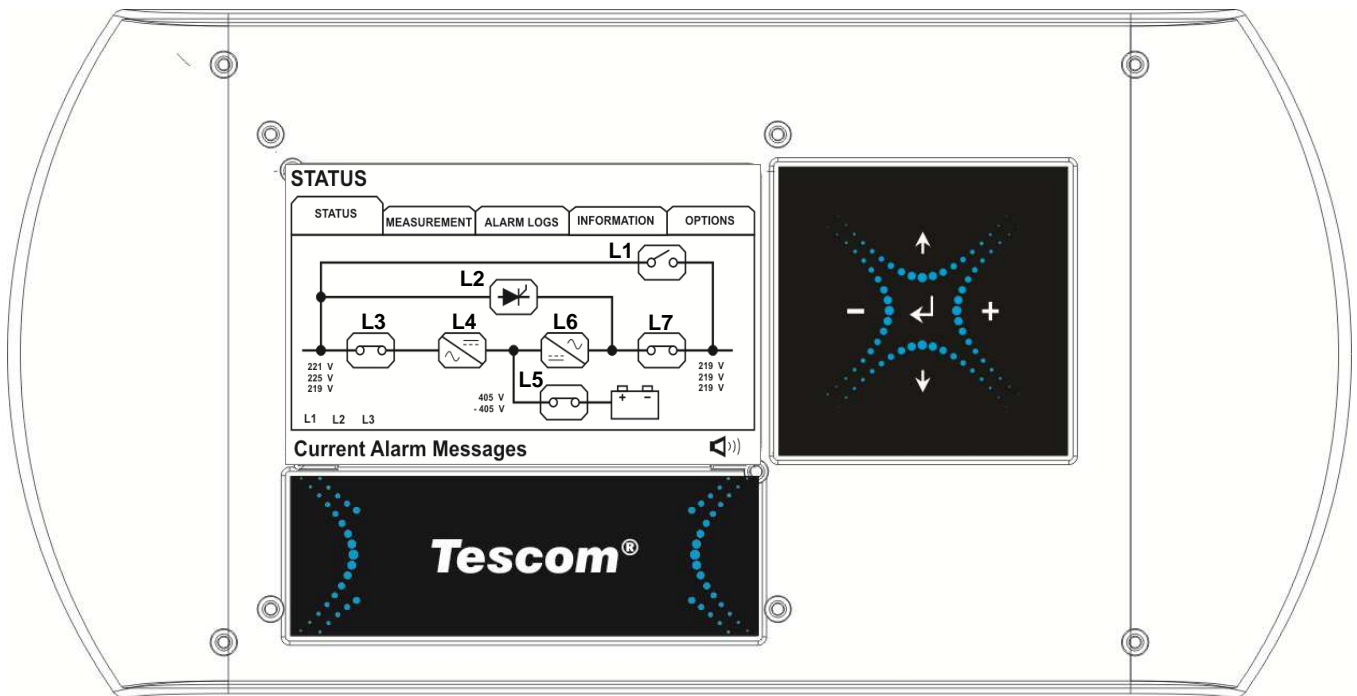

Figure 3.1 Control panel of the UPS

- L1 : Maintenance bypass switch**
- L2 : Load on bypass indicator lamp**
- L3 : Input voltage indicator lamp**
- L4 : Rectifier run pilot lamp**
- L5 : Battery operation indicator lamp**
- L6 : Load on UPS indicator lamp**
- L7 : Output switch on indicator lamp**

There are 5 control buttons on the UPS Front panel ,ENTER button provides selection declaration, up and down buttons provides to surf on menus, (+) and (-) buttons are used for adjustments or option selection.

### 3.2 Front Panel Menu Descriptions :

By using (↑), (↓) and ENTER buttons you can access the following menus. At the end of each menu there is <ENTER> EXIT message will be showed, if you press enter you will exit to upper menu. All menus have 3 or 4 levels.

## Main menu (Level 1)

	Menu	Usage
1	<b>STATUS</b>	→ Enter Status menu
2	<b>MEASUREMENTS</b>	→ Enter Measurements menu
3	<b>ALARM LOGS</b>	→ Enter Alarm logs menu
4	<b>INFORMATION</b>	→ Enter Information menu
5	<b>OPTIONS</b>	→ Enter Options menu
6	<b>COMMAND</b>	→ Enter Command menu
7	<b>TIME</b>	→ Enter Time menu
8	<b>SERVICE</b>	→ Enter Service menu
9	<b>PASSWORD</b>	→ Enter Password screen
10	<b>ADJUST</b>	→ Enter Adjust menu
	<b>Goto 1</b>	

## Sub menus (Level 2)

Level 1	Level 2	Page	Level 3
<b>STATUS</b>	Status of the UPS		
<b>MEASUREMENTS</b>	INPUT		Input measurements
	BYPASS		Bypass measurements
	INVERTER		Inverter measurements
	OUTPUT		Output measurements
	DC		DC measurements
	GENERAL		General measurements
	ENTER - EXIT		
<b>ALARM LOGS</b>	UPS LOG RECORD	Page1	
	ENTER CLEAR LOG	Page1	
<b>INFORMATION</b>	RS232 Comm 1:--	Page1	
	RS232 Comm 2:--	Page1	
	Maximum UPS power	Page1	
	Nominal voltage and frequency	Page1	
	Inverter firmware version	Page2	
	PFC firmware version	Page2	
	Panel firmware version	Page2	
	UPS Model	Page3	
	Communication protocol	Page3	
Chassis nr	Page3		
<b>OPTIONS</b>	LCD OPTIONS		LCD panel options
	COMMUNICATION OPTIONS		Communication options
	ALARM OPTIONS		Alarm options
	BYPASS OPTIONS		Bypass options
<b>COMMAND</b>	By-pass transfer	Page1	
	Boost charge start	Page1	
	Short battery test start	Page1	
	Relay check	Page2	
	Dialup modem programming	Page2	
	Alarm sound ON/OFF	Page3	
	Warning sound interval	Page3	
	ENTER - EXIT		
<b>TIME</b>	Current time	Page1	
	Current date	Page1	
	Set hour	Page2	
	Set minute	Page2	
	Set day	Page3	

Level 1	Level 2	Page	Level 3
	Set month	Page3	
	Set year	Page3	
	Update time and date	Page4	
	ENTER - EXIT		
<b>SERVICE</b>	Operating hourmeter	Page1	
	Maximum load	Page1	
	ENTER Fault reset	Page1	
	Fan maintenance hourmeter	Page2	
	Batt.maintenance hourmeter	Page2	
	General maintenance hourmeter	Page2	
	Logout command	Page3	
	ENTER - EXIT		
<b>PASSWORD</b>	Getting service code	Page1	
	Type service password	Page1	
	Type user password	Page1	
	ENTER - EXIT		
<b>ADJUST</b>			
(in English)	Group adjustments		Automatic settings
	Inverter factory options		Options list
	Rectifier factory options		Options list
	Panel adjustments		Options list
	AC input adjustments		AC input settings
	AC Bypass adjustments		AC bypass settings
	AC output adjustments		AC output settings
	DC adjustments		DC settings
	Power adjustments		Power settings
	ENTER - EXIT		

### 3.2.1 MEASUREMENTS menu

All measured values of the UPS can be monitored from this menu.

Use up and down buttons to move on submenu

#### MEASUREMENTS / INPUT (Level 2)

All rectifier input measurements are located in this menu, use up and down buttons to move on submenu

MEASUREMENTS / INPUT (Level 2)	
P-N L1 L2 L3	Page header
V: 221/222/223 V	Phase to neutral measured AC input voltages
I: 000/000/000 A	Measured RMS AC input phase currents
P-P L13 L21 L32	Page header
V: 381/382/383 V	Phase to phase measured AC input voltages
FREQ: 49.6 Hz	Measured rectifier input frequency

#### MEASUREMENTS / BYPASS (Level 2)

All by-pass input measurements are located in this menu, use up and down buttons to move on submenu

MEASUREMENTS / BYPASS (Level 2)	
P-N L1 L2 L3	Page header
V: 221/222/223 V	Phase to neutral measured AC bypass input voltages
OK OK --	Bypass voltage status
P-P L13 L21 L32	Page header
V: 381/382/383 V	Phase to phase measured AC bypass input voltages
FREQ: OK / 50.0 Hz	Measured bypass input frequency

#### MEASUREMENTS / INVERTER MENU (Level 2)

All inverter measurements are located in this menu, use up and down buttons to move on submenu

MEASUREMENTS / INVERTER (Level 2)	
P-N L1 L2 L3	Page header
V: 221/222/223 V	Phase to neutral measured AC Inverter output voltages
FREQ: 50.0 Hz	Measured Inverter output frequency

#### MEASUREMENTS / OUTPUT MENU (Level 2)

All UPS output measurements are located in this menu, use up and down buttons to move on submenu

MEASUREMENTS / OUTPUT Page 1 (Level 2)	
P-N L1 L2 L3	Page header
V: 221/222/223 V	Phase to neutral measured AC UPS output voltages
I: 00.0/00.0/00.0 A	Measured AC RMS load currents
P-P L13 L21 L32	Page header
V: 381/382/383 V	Phase to phase measured AC UPS output voltages
FREQ: 50.0 Hz	Measured UPS output frequency

Left previous page, right next page

MEASUREMENTS / OUTPUT Page 2 (Level 2)	
L1 L2 L3	Page header
Load 000/000/000 %	Measured load percentage
KW 000.0/000.0/000.0	Measured output watt power
KVA 000.0/000.0/000.0	Measured output KVA power
PF: ---- ---- ----	Load power factor
C.F: 0.0 / 0.0 / 0.0	Load crest factor

Left previous page, right next page

### MEASUREMENTS / DC MENU (Level 2)

All DC measurements are located in this menu, use up and down buttons to move on submenu

MEASUREMENTS / DC (Level 2)	
VBAT 405/-405 V	Measured battery voltages
ICHRG 00.0/00.0 A	Measured battery charge currents
IDSCHRG 00.0/00.0 A	Measured battery discharge currents
BATTERIES : 30 x 2	Batteries in one group
PAR. BAT : 1	Parallel battery groups
BATT. A/H : 007 Ah	Battery amper / hour rating
BACKUP TIME 0000 min	Calculated remaining time

### MEASUREMENTS / GENERAL MENU

Temperature measurements are located in this menu, use up and down buttons to move on submenu

MEASUREMENTS / GENERAL (Level 2)	
TH1: ---- C	Measured external sensor temperature
TH2: 24.2 C	Measured battery cabinet inside temperature
TH3: ---- C	Measured internal sensor temperature

### 3.2.2 ALARM LOGS MENU

Use this menu to see the alarm log records

ALARM LOGS Page 1 (Level 1)	
>191>03.10.12 14:33:26	Event no ,date and time (up and down buttons move)
>000>07.12.12 16:58:26	Event no ,date and time (up and down buttons move)
>001>07.12.12 12:24:26	Event no ,date and time (up and down buttons move)
ALARM LOGS	Alarm Logs
- - - PRESS & HOLD ENTER FOR 3 SEC TO CLEAR LOGS - - -	

### 3.2.3 INFORMATION MENU

Some usefull informations are located in this menu , use up and down buttons to move on submenu

INFORMATION MENU Page 1 (Level 1)	
RS232 COMM: 1:--	RS232 activity indicator for com1
RS232 COMM: 2:--	RS232 activity indicator for com2
MAX POWER (VA): 60000	Maximum ups output power as VA
NOMINAL VALUE:220/050 220/050	Nominal input, output voltage and frequency
INV VERSION: 00001	Inverter module firmware version
PFC VERSION: 00001	PFC rectifier module firmware version
LCD VERSION: 00001	Front panel modul firmware version
MODEL: NEO 60	Model name of the UPS

Up previous page, down next page

INFORMATION MENU Page 2 (Level 1)	
Protocol:TX301	Communication protocol version
Chassis nr: 123456	UPS chassis nr

Up previous page, down next page

### 3.2.4 OPTIONS MENU

Use up and down buttons to move cursor on submenu at the end of page you move to next page. Menu has 3 level structure, if user password is enabled some parameters requires user password.

Level 2 LCD panel options group			
	Panel language selection	Page1	
	Button click ON/OFF	Page1	
	LCD backlight brightness	Page1	
	Backlight delay	Page1	
	Backlight dim.delay	Page1	
	ENTER - EXIT	Page1	

OPTIONS / LCD OPTIONS Page 1 (Level 1)	
LANGUAGE:ENGLISH	Press enter to select change panel language
CLICK: ON/OFF	Press enter to select buton click sound ON/OFF
BACKLIGHT: 08	Press enter to select LCD backlight brightness adjust
BL DELAY:CLOSED	Backlight delay
BL DIM:CLOSED	Back light half option selection
ENTER - EXIT	ENTER exit to upper menu

Up upper line, down next line ,(+) or (-) options ,ENTER select an option

Level 2 – Communication options			
	Remote control ON/OFF	Page1	
	COM2 port function	Page1	
	SNMP internal/external	Page1	
	REPO input ON/OFF	Page1	
	RELAY-ALARM ASSIGN	Page1	
	ENTER - EXIT	Page1	

OPTIONS / COMMUNICATION OPTIONS Page 1 (Level 2)	
REMOTE CNTRL: ON/OFF	Press enter to select remote control ON/OFF
COM2:SERVICE PORT	Com 2 serial port function selection
SNMP : INTERNAL/EXTERNAL	SNMP adaptor location
REPO : ON / OFF	Emergency stop input enabled or disabled
RELAY-ALARM ASSIGN	Press enter to assign alarm
ENTER - EXIT	ENTER exit to upper menu

Up upper line, down next line ,(+) or (-) options, ENTER select an option

RELAY-ALARM ASSIGN Page 1 (Level 3)	
RELAY 1:	Left and right buton relay function selection
RELAY 2:	Left and right buton relay function selection
RELAY 3:	Left and right buton relay function selection
RELAY 4:	Left and right buton relay function selection
RELAY 5:	Left and right buton relay function selection (option)
RELAY 6:	Left and right buton relay function selection (option)

RELAY-ALARM ASSIGN Page 2 (Level 3)	
RELAY 7:	Left and right buton relay function selection (option)
RELAY 8:	Left and right buton relay function selection (option)
RELAY 9:	Left and right buton relay function selection (option)
RELAY 10:	Left and right buton relay function selection (option)
RELAY 11:	Left and right buton relay function selection (option)
RELAY 12:	Left and right buton relay function selection (option)
ENTER - EXIT	ENTER exit to upper menu

Up upper line, down next line ,(+) or (-) options, ENTER select an option

Level 2 Alarm options			
	WARNING INTRVL	Page1	
	WARNING LOG ON/OFF	Page1	
	STATUS LOG ON/OFF	Page1	
	ALF RESTART USER/AUTO	Page1	
	ENTER - EXIT	Page1	

OPTIONS / ALARM OPTIONS Page 1 (Level 3)	
WARNING INTRVL:10 sc	Warning beep interval adjustment in seconds
WARNING LOG:ON/OFF	Press enter to select warning LOG record ON/OFF
STATUS LOG:ON/OFF	Press enter to select status log record ON/OFF
ALF RESTART: USER/AUTO	During mains restore start USER/AUTO
ENTER - EXIT	ENTER exit to upper menu

Level 3 - Bypass options			
	VAT TRANSFER ON/OFF	Page1	
	GEN. BYPASS FORBIDDEN/FREE	Page1	
	GEN. SET SYNC XTAL/SYNC	Page1	
	OPERAT. MOD	Page1	ONLINE / ECONO / SYNC / PARALLEL
	ENTER - EXIT	Page1	

OPTIONS / BYPASS OPTIONS Page 1 (Level 3)	
VAT TRANSFER:ON/OFF	Press enter to select VAT transfer system ON/OFF
GEN SET BYP:FORBID/FREE	Press enter to select bypass to generator FORBID/FREE
GEN SET SYNC:XTAL/SYNC	Press enter to select generator synchron XTAL/SYNC
OPERAT. MOD	Press enter to select mode ONLINE / ECONO / SYNC / PARALLEL
ENTER - EXIT	ENTER exit to upper menu

### 3.2.5 COMMAND MENU

This menu contains UPS commands be carefull while using commands. Use up and down buttons to move cursor on submenu at the end of page you move to next page. <ENTER> button applies the related command.

COMMAND MENU Page 1 (Level 1)	
ENTER <BYPASS>	ENTER transfer the load to bypass
ENTER <BOOST>	ENTER start boost charge mode
ENTER B.TEST > 405	ENTER start short battery test
RELAY TEST:OFF	Left and right test dry contact relays
ENTER : MODEM INIT	ENTER initialize dialup modem
ALARM SOUND: ON/OFF	Press enter to select disable alarm buzzer

### 3.2.6 TIME MENU

You can see Time and date information of the RTC in the UPS ,also you can set date and time from this menu.



Follow the arrows to set date and time

### 3.2.7 SERVICE MENU

This menu contains some helpfull service information and some commands. Use up and down buttons to move cursor on submenu at the end of page you move to next page.

SERVICE MENU Page 1 (Level 1)	
HOURLMETER:00075	Total operating hour of the UPS
MAXLOAD:015 020 025 %	From power on recorded maximum power
ENTER<FAULT RESET>	ENTER fault reset
FAN MAINT: 01000	Remaining hours to FAN maintenance
BAT MAINT :01200	Remaining hours to battery maintenance
GEN.MAINT: 00500	Remaining hours to general maintenance
LOGOUT: --	ENTER Exit from service login status

If maintenance counters are disabled CANCEL word is shown.



---

---

### 3.2.8 ADJUST MENU

This menu is prepared for service purposes there is no user adjustable parameter in this menu.

### 3.2.9 USER PASSWORD

Some commands or some option selections are required user password, if menu position is required password window comes to screen and UPS asks for user password. If you lost user password our service personnel will recover your user password.

User password is 4 digits numbers, move cursor with left and right buttons, select digit and adjust the number with up and down buttons. Do this for all digits and if password is typed completely press ENTER button if the password is correct A43 USER LOGIN message will be shown on the LCD panel of the UPS.

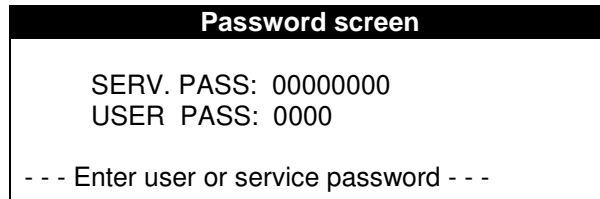

### 3.3 Alarms and warning messages

The internal structure of the DS300HT Series UPS is modular, these are:

- PFC Rectifier module
- Inverter module
- Front panel module

Module alarms and warnings are categorized according to modules at the front of the Alarm or warning message module information is added:

- RXX Rectifier alarms and warnings
- AXX Inverter alarms and warnings
- LXX LCD front panel alarms and warnings

More than one alarm can be shown on the UPS front panel with time shared order. If 4 alarms are occurred at the same time every 2 seconds 1 message will be showed, next 2 seconds 2.message will be showed etc..

If A00 or R00 Alarm is shown on the LCD panel we understand that there is a system fault at the related module. We saw the message in the A00 INV FAULT = XXXX or R00 PFC FAULT = XXXX format. Numbers shown in X determines the status code which tells the problem to us. See status code table for details of codes.

Rectifier module alarm codes		
REC CODE = XXXX		XXXX SYSTEM fault occurred at the rectifier module
R00 REC FAULT = XXXX	Fault	Rectifier AC input voltage is high <b>CALL SERVICE !</b>
R01 AC INPUT HIGH	Alarm	Rectifier AC input voltage is low
R02 LINE FAILURE	Alarm	Rectifier DC output voltage is high
R03 DC BUS HIGH	Alarm	The rectifier DC output voltage is high, rectifier stop
R05 FREQ TOLER	Alarm	Rectifier input frequency out of tolerant
R06 OVERTEMPERATURE	Alarm	Rectifier heatsink temperature high
R07 BLACKOUT	Alarm	Short voltage blackout at rectifier AC input
R08 I/P OVERCURRENT	Alarm	Rectifier IGBT saturation alarm
R09 ROTATE PHASE	Alarm	Rectifier input phase sequence incorrect
R14 PFC MANUAL STOP	Alarm	Inverter module stopped rectifier
R15 DC LOW	Alarm	DC BUS voltage is lower than DC rectifier start voltage
R17 BATTERY TEST	Warning	Currently battery test is performing
R18 BOOST CHARGE	Warning	Currently rectifier is in boost charge mode
R19 AC HIGH	Alarm	AC Peak voltage is bigger than 20% of nominal range
R20 INPUT CB OPEN	Warning	Input CB is off
R21 PFC STOP	Warning	Currently Rectifier module stop
R22 POS CHG LIMIT	Warning	(+)Battery charge current limited
R23 NEG CHG LIMIT	Warning	(-)Battery charge current limited
R24 WAITING DC BUS	Warning	Rectifier is waiting DC BUS to raise for startup
R25 BATTERY FAILURE	Warning	Battery test failed
R26 BATT TEMP SENSOR	Warning	Battery temperature sensor is defected or not connected
R27 BATT TEMP HIGH	Warning	Battery ambient temperature is high
R29 PFC RESET	Warning	Rectifier module power on
R30 PLEASE WAIT	Warning	Rectifier waits as adjusted startup delay
R31 RECTIFIER START	Warning	Rectifier is in soft start stage

Panel module alarm codes		
L01 TH1 TEMP HIGH	Warning	TH1 temperature is high
L02 TH2 TEMP HIGH	Warning	TH2 temperature is high
L03 TH1 TEMP LOW	Warning	TH1 temperature is low
L04 TH2 TEMP LOW	Warning	TH2 temperature is low
L05 FAN MAINT	Warning	FAN maintenance time
L06 BATTERY MAINT	Warning	Battery maintenance time
L07 OPT MAINTENANCE	Warning	Optional maintenance time
L08 TH1 SENSOR FAIL	Warning	TH1 temperature sensor failure
L09 TH2 SENSOR FAIL	Warning	TH2 temperature sensor failure
L10 ENTER FAULT RESET	Warning	UPS is waiting fault reset for startup
L11 BATT CB OPEN	Warning	External interactive battery switch is off
L12 GENERAL MAINT	Warning	General maintenance time
L13 PFC CAN COMM ERR	Warning	PFC module CAN communication timeout
L14 INV CAN COMM ERR	Warning	INV module CAN communication timeout

Inverter module alarm codes		
INV CODE = 0XXX		Current inverter module status code
A00 INV FAULT = XXXX	Hata	XXXX fault occurred at the inverter module <b>CALL SERVICE !</b>
A01 O/P OVERCURRENT	Alarm	IGBT saturation alarm on inverter module
A02 OVERTEMP SHUT	Alarm	Overtemperature at inverter power module
A03 BATT HIGH	Alarm	Inverter module measured battery voltage high
A04 OUTPUT V.LOW	Alarm	Inverter output voltage is low
A05 OUTPUT V.HIGH	Alarm	Inverter output voltage is high
A06 OVERLOAD SHUT	Alarm	Overload at UPS output
A07 SHORT CIRCUIT	Alarm	Short circuit at UPS output

A08 ON MAINTENANCE	Alarm	Maintenance by-pass switch on
A09 MANUAL BYPASS	Alarm	Load is transferred to by-pass from front panel
A10 BATTERY LOW SHUT	Alarm	Inverter measured battery voltage is low (shutdown level)
A11 REPO STOP	Alarm	External REPO input signal sensed
A12 DC BALANCE BAD	Alarm	Before inverter start filter capacitors dont discharged
A13 PEAK CURRENT	Alarm	Very high current at the UPS output
A14 INV NOT START	Alarm	Inverter module start failed
A17 BYPASS FAILURE	Warning	By-pass input voltage failure
A18 BYPASS VOLT	Warning	By-pass input voltage out of tolerance
A19 BYP FREQ.TOLER	Warning	By-pass input frequency out og tolerance
A20 OVERLOAD	Warning	Currently the load exceeded 100% capacity
A21 OVERTEMP	Warning	Currently inverter power modul heatsink temperature is high
A22 OUTPUT OFF	Warning	There is no UPS output voltage
A23 ON BYPASS	Warning	Load is on bypass
A24 REVERSE CURRENT	Warning	Regenerative backfeed to UPS output
A25 INV RESET	Warning	Inverter module power on
A26 BATTERY LOW	Warning	Batteries are going to full discharge
A27 GENERATOR MODE	Warning	Generator set is running
A28 O/P PHASE LOSS	Warning	Anyone of the UPS output phases there is no voltage
A29 SYNCHRON BAD	Warning	Inverter is not synchron to by-pass input
A30 SHORT CIRCUIT	Warning	Short circuit ocured at the UPS output currenty normal
A31 OUTPUT SWITCH	Warning	Output switch of the UPS is off
A32 SERVICE LOGIN	Warning	Service login active
A34 BYP ROTATE PHASE	Warning	By-pass phase sequency incorrect
A35 INV STOP	Warning	Inverter module interrupted
A36 INV DC DOWN	Warning	DC BUS voltage is less then 120 volts DC
A37 AC CURR LIMIT	Warning	Inverter output current limited
A38 FUSE FAILURE	Warning	Any fuse in UPS is blownd
A39 PSP FAILURE	Alarm	Inverter control board power supply out of tolerant
A40 INVERTER START	Warning	Inverter is in soft start stage wait for finish
A43 USER LOGIN	Warning	User logged in to UPS
A45 SERV.PASSWORD	Fault	For UPS startup service password required

If any alarm shown on the LCD panel without A00 and R00 message UPS will start automatically if the conditions are normal. But if you see A00 or R00 code with any alarm together you must CALL SERVICE ! If the message is warning UPS continues to run there is no problem.

To support technical service status cods are used, each status code tells different event to us.

### 3.4 STATUS CODES

#### Inverter module status codes

<b>INV L1-L2-L3 phase status codes</b>	
163	During soft start at the end of 4 seconds L1 output voltage is less then 30 volts AC
263	During soft start at the end of 4 seconds L2 output voltage is less then 30 volts AC
363	During soft start at the end of 4 seconds L3 output voltage is less then 30 volts AC
164	During soft start at the end of 4 seconds L1 output voltage is bigger then (output high/2) value
264	During soft start at the end of 4 seconds L2 output voltage is bigger then (output high/2) value
364	During soft start at the end of 4 seconds L3 output voltage is bigger then (output high/2) value
165	During inverter run the L1 phase AC output voltage is bigger then output high alarm level
265	During inverter run the L2 phase AC output voltage is bigger then output high alarm level
365	During inverter run the L3 phase AC output voltage is bigger then output high alarm level
166	During inverter run the L1 phase AC output voltage is less then output low alarm level
266	During inverter run the L2 phase AC output voltage is less then output low alarm level
366	During inverter run the L3 phase AC output voltage is less then output low alarm level
167	L1 phase by-pass SCR must be off but at there is AC voltage at the L1 output of the UPS
267	L2 phase by-pass SCR must be off but at there is AC voltage at the L2 output of the UPS
367	L3 phase by-pass SCR must be off but at there is AC voltage at the L3 output of the UPS
168	L1 phase overload shutdown
268	L2 phase overload shutdown
368	L3 phase overload shutdown
169	Overcurrent occured on L1 phase longer then allowed time
269	Overcurrent occured on L2 phase longer then allowed time
369	Overcurrent occured on L3 phase longer then allowed time
170	On L1 phase momentary short circuit conditions occured but now inverter is running
270	On L2 phase momentary short circuit conditions occured but now inverter is running
370	On L3 phase momentary short circuit conditions occured but now inverter is running
171	On L1 phase output short circuit occured output shutdown
271	On L2 phase output short circuit occured output shutdown
371	On L3 phase output short circuit occured output shutdown
172	Within time window 4 times L1 phase output is less then output low alarm level
272	Within time window 4 times L2 phase output is less then output low alarm level
372	Within time window 4 times L3 phase output is less then output low alarm level
173	Within time window 4 times L1 phase output is higher then output high alarm level
273	Within time window 4 times L2 phase output is higher then output high alarm level
373	Within time window 4 times L3 phase output is higher then output high alarm level
174	On L1 phase UPS output at last 100 milliseconds the alternance don't changed
274	On L2 phase UPS output at last 100 milliseconds the alternance don't changed
374	On L3 phase UPS output at last 100 milliseconds the alternance don't changed
175	On L1 bypass input phase at last 100 milliseconds the alternance don't changed
275	On L2 bypass input phase at last 100 milliseconds the alternance don't changed
375	On L3 bypass input phase at last 100 milliseconds the alternance don't changed
176	On L1 inverter output phase at last 100 milliseconds the alternance don't changed
276	On L2 inverter output phase at last 100 milliseconds the alternance don't changed
376	On L3 inverter output phase at last 100 milliseconds the alternance don't changed
177	L1 phase output current sensor open
277	L2 phase output current sensor open
377	L3 phase output current sensor open

<b>INV L1-L2-L3 phase status codes</b>	
178	Inverter stopped but on inverter L1 phase output still DC voltage sensed
278	Inverter stopped but on inverter L2 phase output still DC voltage sensed
378	Inverter stopped but on inverter L3 phase output still DC voltage sensed
179	During inverter run at last 25 milliseconds the L1 phase output alternance is not changed
279	During inverter run at last 25 milliseconds the L2 phase output alternance is not changed
379	During inverter run at last 25 milliseconds the L3 phase output alternance is not changed
180	At the end of 4 times retry During soft start after 4 seconds still the L1 phase output voltage is less then 30 volts AC
280	At the end of 4 times retry During soft start after 4 seconds still the L2 phase output voltage is less then 30 volts AC
380	At the end of 4 times retry During soft start after 4 seconds still the L3 phase output voltage is less then 30 volts AC
181	At the end of 4 times retry During soft start at the end of 4 seconds L1 output voltage is bigger then (output high/2) value
281	At the end of 4 times retry During soft start at the end of 4 seconds L2 output voltage is bigger then (output high/2) value
381	At the end of 4 times retry During soft start at the end of 4 seconds L3 output voltage is bigger then (output high/2) value
182	During power on L1 phase bypass SCR must be off but at the L1 phase output there is AC voltage
282	During power on L2 phase bypass SCR must be off but at the L2 phase output there is AC voltage
382	During power on L3 phase bypass SCR must be off but at the L3 phase output there is AC voltage
183	L1 phase by-pass SCR must be on but there is only positive alternance at the UPS output
283	L2 phase by-pass SCR must be on but there is only positive alternance at the UPS output
383	L3 phase by-pass SCR must be on but there is only positive alternance at the UPS output
184	L1 phase by-pass SCR must be on but there is only negative alternance at the UPS output
284	L2 phase by-pass SCR must be on but there is only negative alternance at the UPS output
384	L3 phase by-pass SCR must be on but there is only negative alternance at the UPS output
185	L1 phase by-pass SCR must be on but there is no output voltage at the UPS output
285	L2 phase by-pass SCR must be on but there is no output voltage at the UPS output
385	L3 phase by-pass SCR must be on but there is no output voltage at the UPS output
186	Output CB is energized but at the L1 phase output there is only positive alternance
286	Output CB is energized but at the L2 phase output there is only positive alternance
386	Output CB is energized but at the L3 phase output there is only positive alternance
187	Output CB is energized but at the L1 phase output there is only negative alternance
287	Output CB is energized but at the L2 phase output there is only negative alternance
387	Output CB is energized but at the L3 phase output there is only negative alternance
188	Output CB is energized but at the L1 phase output there is no AC voltage
288	Output CB is energized but at the L2 phase output there is no AC voltage
388	Output CB is energized but at the L3 phase output there is no AC voltage
189	During load on by-pass on the L1 output short circuit sensed
289	During load on by-pass on the L2 output short circuit sensed
389	During load on by-pass on the L3 output short circuit sensed
190	On L1 phase output reverse current sensed
290	On L2 phase output reverse current sensed
390	On L3 phase output reverse current sensed
191	During load on inverter ,on L1 phase by-pass line leakage current sensed
291	During load on inverter ,on L2 phase by-pass line leakage current sensed
391	During load on inverter ,on L3 phase by-pass line leakage current sensed

<b>INV DC status codes</b>	
400	DC bus voltage high
401	Inverter controller board power supply 1 out of tolerant
402	Inverter controller board power supply 2 out of tolerant
404	Inverter stop because (+)DC bus voltage is low
405	Inverter stop because (-)DC bus voltage is low
406	Inverter within time window 4 times DC bus voltage is high

<b>INV General status codes tablosu</b>	
500	Inverter received remote power off signal from RS232
501	Inverter received remote power off signal from CAN interface
502	Inverter sensed IGBT fault alarm 4 times within time window (30 minutes)
503	Inverter sensed Overtemperature alarm 4 times within time window (30 minutes)
504	Inverter sensed 3 phase AC O/P voltage low alarm 4 times within time window (30 minutes)
505	Inverter sensed 3 phase AC O/P voltage high alarm 4 times within time window (30 minutes)
506	Inverter Timeout error during eprom read or write
507	Inverter Memory checksum error
508	Inverter 3 output phases overloaded output shutdown
509	Inverter maintenance by-pass switch closed
510	Inverter IGBT fault error
511	Inverter overtemperature shutdown
512	Inverter 3 phase AC output voltage low
513	Inverter 3 phase AC output voltage high
514	Inverter output CB energized but still it looks like not energized
515	Inverter output CB not energized but stil it looks like energized
516	Inverter fault occured for restart password required
517	Inverter output CB energized but at the UPS output there is no 3 phase AC voltage
518	Inverter By-pass voltage is OK but at the UPS output there is no 3 phase AC voltage

<b>INV Control activity status codes</b>	
612	INV Over RS232 interface battery quantity updated
613	INV Over CAN1 interface battery quantity updated
614	INV Over RS232 interface by-pass and output frequency updated
615	INV Over CAN1 interface by-pass and output frequency updated
616	INV Over RS232 interface By-pass and output voltage updated
617	INV Over CAN1 interface By-pass and output voltage updated
618	INV Over RS232 interface factory options updated
619	INV Over CAN1 interface factory options updated
620	INV Over RS232 interface user options updated
621	INV Over CAN1 interface user options updated
622	INV Over RS232 interface general test command received
623	INV Over CAN1 interface general test command received
624	INV Over RS232 interface transfer load to by-pass command received
625	INV Over CAN1 interface transfer load to by-pass command received
626	INV Over RS232 interface transfer load to UPS command received
627	INV Over CAN1 interface transfer load to UPS command received
628	INV Over RS232 interface Copy operating RAM to Factory settings zone command received
629	INV Over CAN1 interface Copy operating RAM to Factory settings zone command received
630	INV Over RS232 interface Copy factory settings to operating RAM command received
631	INV Over CAN1 interface Copy factory settings to operating RAM command received
632	INV Over RS232 interface Copy operating RAM to User settings zone command received
633	INV Over CAN1 interface Copy operating RAM to User settings zone command received
634	INV Over RS232 interface regenerative back feed activated
635	INV Over CAN1 interface regenerative back feed activated

---



---

636	INV Over RS232 interface fault reset command received
637	INV Over CAN1 interface fault reset command received
638	INV Over RS232 interface short battery test command received
639	INV Over CAN1 interface short battery test command received
640	INV Over RS232 interface long battery test command received
641	INV Over CAN1 interface long battery test command received
642	INV Over RS232 interface battery test cancel command received
643	INV Over CAN1 interface battery test cancel command received
644	INV Over RS232 interface start boost charge command received
645	INV Over CAN1 interface start boost charge command received
646	INV Over RS232 interface stop boost charge command received
647	INV Over CAN1 interface stop boost charge command received
648	INV Over RS232 interface PFC short stop command received
649	INV Over CAN1 interface PFC short stop command received
650	INV Over RS232 interface generator mode start command received
651	INV Over CAN1 interface generator mode start command received
652	INV Over RS232 interface start sleep mode command received
653	INV Over CAN1 interface start sleep mode command received
654	INV Over RS232 interface exit sleep mode command received
655	INV Over CAN1 interface exit sleep mode command received
656	INV Over RS232 interface service login command received
657	INV Over CAN1 interface service login command received
658	INV Over RS232 interface logout command received
659	INV Over CAN1 interface logout command received
660	INV Over RS232 interface user login command received
661	INV Over CAN1 interface user login command received
662	INV over RS232 service level fault reset command received
663	INV over CAN1 service level fault reset command received
664	INV over RS232 delete fault profile memory command received
665	INV over CAN1 delete fault profile memory command received
666	INV over RS232 start regenerative mode command received
667	INV over CAN1 start regenerative mode command received
668	INV over RS232 user level fault reset command received
669	INV over CAN1 user level fault reset command received

### PFC rectifier status codes

PFC L1-L2-L3 phase status codes	
1101	PFC L1 phase AC input current LEM sensor error
1201	PFC L2 phase AC input current LEM sensor error
1301	PFC L3 phase AC input current LEM sensor error
1102	L1 phase AC input voltage sample is irregular or DC
1202	L2 phase AC input voltage sample is irregular or DC
1302	L3 phase AC input voltage sample is irregular or DC
1103	PFC AC rectifier input voltage is lower then <b>R2187</b> on L1 phase input
1203	PFC AC rectifier input voltage is lower then <b>R2187</b> on L2 phase input
1303	PFC AC rectifier input voltage is lower then <b>R2187</b> on L3 phase input
1104	PFC AC rectifier input voltage is higher then <b>R2186</b> on L1 phase input
1204	PFC AC rectifier input voltage is higher then <b>R2186</b> on L2 phase input
1304	PFC AC rectifier input voltage is higher then <b>R2186</b> on L3 phase input
1105	PFC L1 phase AC peak input voltage is bigger 20% from nominal range value
1205	PFC L2 phase AC peak input voltage is bigger 20% from nominal range value
1305	PFC L3 phase AC peak input voltage is bigger 20% from nominal range value
1106	PFC L1 phase AC input current limited
1206	PFC L2 phase AC input current limited
1306	PFC L3 phase AC input current limited

### PFC DC status codes

1400	PFC +DC bus voltage is higher then <b>R2131 adjustment</b>
1401	PFC -DC bus voltage is higher the <b>R2131 adjustment</b>
1402	PFC DC LEM current sensor error
1403	PFC module +DC BUS voltage high alarm repeated 4 times within <b>R2166</b> time window
1404	PFC module -DC BUS voltage high alarm repeated 4 times within <b>R2166</b> time window
1405	PFC board isolated power supply voltage failure
1406	PFC rectifier power component DC leakage sensed

### PFC General status codes

1500	PFC remote emergency power off command received from RS232 or CAN interface
1501	PFC IGBT saturation alarm
1502	PFC overcurrent alarm
1503	PFC input CB not energized but still it looks like energized
1504	PFC input CB energized but still it looks like not energized
1505	PFC eeprom timeout error
1506	PFC eeprom memory error
1507	PFC modul IGBT fault alarm repeated 4 times within <b>R2165</b> time window
1508	PFC modul overtemperature alarm repeated 4 times within <b>R2167</b> time window
1509	PFC 3 phase AC power failure on UPS input (2.5 seconds later after mains failure)
1510	PFC 3 phase AC rectifier input voltage is high (2.5 seconds later after mains failure)
1511	PFC AC power failure on L1-L2 phases(phase to phase)
1512	PFC AC power failure on L1-L3 phases(phase to phase)
1513	PFC AC power failure on L2-L3 phases(phase to phase)
1514	PFC AC input voltage high on L1-L2 phases(phase to phase)
1515	PFC AC input voltage high on L1-L3 phases(phase to phase)
1516	PFC AC input voltage high on L2-L3 phases(phase to phase)



<b>PFC Control activity status codes</b>	
1612	PFC Battery quantity updated over RS232 interface
1613	PFC Battery quantity updated over CAN interface
1614	PFC rectifier Input frequency range updated over RS232 interface
1615	PFC rectifier Input frequency range updated over CAN interface
1616	PFC factory settings updated over RS232 interface
1617	PFC factory settings updated over CAN interface
1618	PFC rectifier Input AC voltage range updated over RS232 interface
1619	PFC rectifier Input AC voltage range updated over CAN interface
1626	PFC over RS232 interface Test AC input signals command received
1627	PFC over CAN interface Test AC input signals command received
1628	PFC over RS232 interface copy operating RAM to Factory settings memory command received
1629	PFC over CAN1 interface copy operating RAM to Factory settings memory command received
1630	PFC over RS232 interface Copy factory settings to operating RAM command received
1631	PFC over CAN1 interface Copy factory settings to operating RAM command received
1632	PFC over RS232 interface Copy operating RAM to User settings memory command received
1633	PFC over CAN1 interface Copy operating RAM to User settings memory command received
1636	PFC over RS232 memory checksum lock command received
1637	PFC over CAN1 memory checksum lock command received
1638	PFC over RS232 interface start short battery test command received
1639	PFC over CAN1 interface start short battery test command received
1640	PFC over RS232 interface start long battery test command received
1641	PFC over CAN1 interface start long battery test command received
1642	PFC over RS232 interface cancel battery test command received
1643	PFC over CAN1 interface cancel battery test command received
1644	PFC over RS232 interface start boost charge mode command received
1645	PFC over CAN1 interface start boost charge mode command received
1646	PFC over RS232 interface stop boost charge command received
1647	PFC over CAN1 interface stop boost charge command received
1648	PFC over RS232 interface short stop command received
1649	PFC over CAN1 interface short stop command received
1650	PFC over RS232 interface start generator mode command received
1651	PFC over CAN1 interface start generator mode command received
1652	PFC over RS232 interface enter sleep mode command received
1653	PFC over CAN1 interface enter sleep mode command received
1654	PFC over RS232 interface exit from sleep mode command received
1655	PFC over CAN1 interface exit from sleep mode command received
1656	PFC over RS232 interface service login command received
1657	PFC over CAN1 interface service login command received
1658	PFC over RS232 interface logout command received
1659	PFC over CAN1 interface logout command received
1660	PFC over RS232 interface user login command received
1661	PFC over CAN1 interface user login command received
1662	PFC over RS232 interface service level fault reset command received
1663	PFC over CAN1 interface service level fault reset command received
1664	PFC over RS232 delete fault profile memory command received
1665	PFC over CAN1 delete fault profile memory command received
1666	PFC over RS232 interface backfeed regenerative energy to mains input command received
1667	PFC over CAN1 interface backfeed regenerative energy to mains input command received
1668	PFC over RS232 user level fault reset command received
1669	PFC over CAN1 interface user level fault reset command received

For detailed description of the status codes please refer to servic manual

---

---

### 3.5 Alarm messages and quick troubleshooting

Alarm codes and messages are showed at the 4.line of the LCD panel various messages tells different events at some messages user can make some simple controls and they can decide that they must call service or not.

NOTE : If **R00 REC FAULT = XXXX** or **A00 INV FAULT = XXXX** message is shown on the LCD panel the other alarm or warning messages will not be shown.

#### **R00 REC FAULT = XXXX**

Call service

#### **R01 AC INPUT HIGH**

The input voltage of the UPS is very high check the AC input voltage if really high wait until the voltage is normal.

#### **R02 LINE FAILURE**

The input voltage of the UPS is very low ,check the AC input voltage if the input voltage is low wait until the AC input voltage is normal.

#### **R03 DC BUS HIGH**

Call service

#### **R05 FREQ TOLER**

The AC input voltage frequency of the UPS is out of tolerance wait until the input frequency is normal.

#### **R06 OVERTEMPERATURE**

Overtemperature at rectifier module call service.

#### **R07 BLACKOUT**

There is a short blackout at the AC input voltage of the UPS, this is temporary wait until the AC input voltage is normal.

#### **R08 I/P OVERCURRENT**

Call service

#### **R09 ROTATE PHASE**

The phase sequency at the UPS input is reverse please refer to a technical personnel to provide correct phase sequency

#### **R14 PFC MANUAL STOP**

This message shows that rectifier is stopped for any alarm reason check the other alarm shown together with this alarm.

#### **R15 DC LOW**

DC BUS voltage or battery voltage is very low wait 10 minutes then call service

#### **R17 BATTERY TEST**

For 30 seconds UPS is performing battery test at the end of the test UPS decides batries are OKEY or not, then UPS returns to normal operation automatically.

#### **R18 BOOST CHARGE**

For 10 hours boost charge mode is activated from UPS, at the end of 10 hours UPS returns to normal charge mode

#### **R19 AC HIGH**

The AC input vottage of the UPS is 20% higher then nominal input vottage, wait until the AC input voltage is normal.

---

---

**R20 INPUT CB OPEN**

The input of the UPS is isolated from mains power with contactor ,this message will be shown with another alarm always. Check the other alarm code.

**R21 PFC STOP**

Rectifier is stopped itself wait it must start again, another alarm code shows the reason of the rectifier stop. Wait for 1 minute if alarm continues call service.

**R22 POS CHG LIMIT, R23 NEG CHG LIMIT**

This message is normal if the battery charge current is rached to limit value during battery charge.

**R24 WAITING DC BUS**

The DC BUS voltage of the UPS is not enough to startup wait 2 minutes if message continues call service.

**R25 BATTERY FAILURE**

At the last battery test one or more defected batteries found, call service.

**R26 BATT TEMP SENSOR**

Battery temperature sensor mulfunction, call service.

**R27 BATT TEMP HIGH**

If batteries are located at the outside of the UPS cabinet check battery ambient temperature if hot use air cooling system. If batteries are internal check the UPS ambient temperature if normal call service.

**L02 TH2 TEMP HIGH, L04 TH2 TEMP LOW**

UPS TH2 cabinet inside temperature is out of tolerance check the followings:

- If UPS air inlets and outlets covred by dust clean
- If any material prevents air flow at UPS air inlets or outlets take the material
- If UPS ambient temperature is high then 45 C ,use air cooling system

**L05 FAN MAINT**

Maintenance due of the cooling fans of the UPS, call service.

**L06 BATTERY MAINT**

Maintenance due of the UPS batteries, call service.

**L08 TH1 SENSOR FAIL, L09 TH2 SENSOR FAIL**

TH1 or TH2 temperature measurement sensors are defected, call service.

**L10 ENTER FAULT RESET**

Call service

**L11 BATT CB OPEN**

The battery switch of the UPS is OFF, in this case UPS runs normally but if mains failure alarm occures the output voltage of the UPS shutdown. Please turn ON the battery switch.

**L12 GENERAL MAINT**

Maintenance due of the general maintenance, call service.

**L13 PFC CAN COMM ERR**

Call service.

**L14 INV CAN COMM ERR**

Call service.

**A00 INV FAULT = XXXX**

Call service.

---

---

### **A01 O/P OVERCURRENT**

Check the new load which are connected to UPS nowadays the total load power maybe exceeds maximum power of the UPS. Otherwise call service.

### **A02 OVERTEMP SHUT**

Inverter modüle heatsink temperature is out of tolerance check the followings:

- If UPS air inlets and outlets covered by dust clean
- If any material prevents air flow at UPS air inlets or outlets take the material
- If UPS ambient temperature is high then 45 C, use air cooling system

### **A03 BATT HIGH**

DC BUS voltage or battery voltage of the UPS is high, if inductive load is used this event sometimes occurs if alarm continues call service.

### **A04 OUTPUT V.LOW**

The output voltage of the inverter is low call service

### **A05 OUTPUT V.HIGH**

The output voltage of the inverter is high call service

### **A06 OVERLOAD SHUT**

The total load which is connected to the UPS is exceeded 100% capacity of the UPS if message continues call service they will check UPS, but probably you need higher power range UPS.

Note: Some load inrush currents causes overload event then current is normal.

### **A07 SHORT CIRCUIT**

There is short circuit at the output of the UPS check installation and loads.

### **A08 ON MAINTENANCE**

The maintenance by-pass switch of the UPS is ON <1>position, there is a lock on this switch which prevents unauthorized personnel use.

### **A09 MANUAL BYPASS**

Load is transferred to by-pass from UPS command menu, transfer the load to the inverter.

### **A10 BATTERY LOW SHUT**

The DC BUS or battery voltage of the UPS is low. If the mains is OKEY call service.  
If there is no mains voltage wait until mains OKEY UPS will start automatically.

### **A11 REPO STOP**

External repo button pressed, to restart turn off and on the UPS

### **A12 DC BALANCE BAD**

Call service

### **A13 PEAK CURRENT**

Very high current measured at the UPS output, check loads

### **A14 INV NOT START**

Call service

### **A17 BYPASS FAILURE, A18 BYPASS VOLT, A19 BYP FREQ.TOLER**

The input of the UPS or by-pass input of the UPS voltage or frequency is out of tolerance ,wait until the voltage is normal if message continues long time check input fuses ,switches etc. at the distribution panel.

### **A20 OVERLOAD**

UPS is currently running but the load percentage exceeds 100% capacity of the UPS ,if this situation continues inverter will stop after a delay.Check the loads at the UPS output.

---

---

### **A21 OVERTEMP**

Inverter module heatsink temperature is high check the followings:

- If UPS air inlets and outlets covered by dust clean
- If any material prevents air flow at UPS air inlets or outlets take the material
- If UPS ambient temperature is high then 45 C, use air cooling system

### **A22 OUTPUT OFF**

During mains failure if the battery backup time is finished this message is normal ,there is no energy so the UPS shutdown the output voltage.

If this message is permanent call service, otherwise wait until the message is deleted automatically from LCD screen.

### **A23 ON BYPASS**

From any reason UPS transferred the load to bypass, check the other alarm code which shown together with this alarm it shows the by-pass reason.

If the UPS stays at this position for a long time call service.

### **A24 REVERSE CURRENT**

Any load such as motors are connected to UPS output and the load in regenerative mode ,it is applying reverse energy to the UPS output. Call service

### **A25 INV RESET**

This is the power on indicator of the inverter modüle, during over on for 10 seconds this message will be shown at the end of 10 seconds the mesage will be cleared.

### **A26 BATTERY LOW**

The DC BUS or battery voltage of the UPS is low, still UPS is running but DC voltage is going down.

If this alarm occures during mains failure it means that there is no energy from batteries this is normal.

But if this alarm occures during mains OKEY call service.

### **A27 GENERATOR MODE**

UPS is running in generator mode when generator set stops UPS returns to normal operating mode automatically.

### **A28 O/P PHASE LOSS**

Call service

### **A29 SYNCHRON BAD**

This is only warning that showa the inverter and by-pass voltages are not synchron to each other ,there is nothing to do wait until they matches.

### **A30 SHORT CIRCUIT**

Shorter then 4 alternance (40 milliseconds) short circuit occured at the output of the UPS, now UPS is running but you must check the installation and loads.

### **A31 OUTPUT SWITCH**

The output switch of the UPS is OFF <0>position, turn on <1>position the output switch

### **A32 SERVICE LOGIN**

Service ersonnel logged in to UPS this is only warning.

### **A34 BYP ROTATE PHASE**

The phase sequency of the by-pass source is not match the UPS output phase sequency. Please check the by-pass phase sequency if wrong change phases.

### **A35 INV STOP**

The message shows that the inverter modüle stopped from any reason ,check the other alarm code which is shown together with this mesage.

---

---

**A36 INV DC DOWN**

Call service

**A37 AC CURR LIMIT**

Alarm shows us the output current is very high (higher than 150%) the UPS limited the output current. This status is temporary but if continues call service.

**A38 FUSE FAILURE**

Call service

**A39 PSP FAILURE**

Call service

**A43 USER LOGIN**

User logged in to UPS this is only warning

**A45 SERV.PASSWORD**

Call service , **UPS start impossible**

---

---

## IV. OPERATING INSTRUCTIONS

### 4.1 INTRODUCTION

After all the electrical connections of UPS have been made and while all the circuit breakers and switches of the device are turned OFF (at "0" position);

1. Check the polarities of battery connections:

Batt. (+) : + V (nominal voltage +336V, float charge voltage +378V)

N Busbar : 0 V (common terminal for "+" and "-" battery groups)

Batt. (-) : - V (nominal voltage -336V, float charge voltage -378V)

2. Check 3-phase AC input and neutral connections (care should be taken for the phase order).

**ATTENTION!!!** TWO CABLES FOR EACH BATTERY GROUP SHOULD BE USED FOR EXTERNAL BATTERY CONNECTION, AND THE COMMON POINT CONNECTION SHOULD BE MADE ON K2 TERMINALS!

**WARNING !** : UPS should never be operated without neutral connection.

3. Check the output load connections of UPS.

### 4.2 OPERATING UPS IN ONLINE MODE

#### 4.2.1 Starting UPS from a completely shut down position:

1. Turn ON S1 (AC Input) switch (switch to "1" position)
2. Turn ON S2 (Bypass) switch (switch to "1" position)
3. Turn ON S4 (AC Output) switch (switch to "1" position)

**ATTENTION!!!** BYPASS VOLTAGE WILL BE CONNECTED TO THE OUTPUT TERMINALS OF UPS WHEN THE ON/OFF SWITCH (S7) IS SWITCHED ON !

4. Turn on S7 (On/Off) switch (to "1" position). LCD panel activates, and "INV RESET" or "PFC RESET" message appears on the display meaning that the rectifier starts to operate.
5. A few seconds later red bypass light (L2) on front panel turns off and green inverter light (L6) turns on. L6 light indicates that the UPS has started normal operation and generating uninterruptible power for the critical load.
6. Turn on S5 switch (to "1" position) to connect the battery group to UPS.
7. UPS is ready and in normal operation now.

#### 4.2.2 Shutting down the UPS

After closing all the critical loads supplied by the UPS output:

1. Turn off S4 (AC Output) switch (to "0" position).
2. Turn off S7 (On/Off) switch (to "0" position).
3. Turn off S5 (Battery) switch (to "0" position).
4. Turn off S2 (Bypass) switch (to "0" position).
5. Turn off S1 (AC Input) switch (to "0" position).

After performing the above procedure, UPS is completely shut-down. In this case PFC rectifier and inverter is not operating and the batteries are not being charged.

---

---

### 4.2.3 Switching the UPS from a Normal Operation to Maintenance Bypass Condition

1. Enter COMMANDS menu by using UP and DOWN buttons on front panel during normal operation. Select ENTER<BYPASS> command by using again the UP and DOWN buttons and pres ENTER button. The critical load is transferred to bypass supply in this case and it is shown at LCD display with **“A09 MANUAL BYPASS”** message. Besides L6 (load on UPS) light on front panel will be off and L2 light (bypass) will be on.
2. Turn on S3 (Maintenance Bypass) switch (after unlocking and taking away the padlock on it) to “1” position.
3. Turn off S7, S5, S1, S2 and S4 switches (to “0” position).

In this case, bypass voltage is connected directly to the output of UPS and the critical load is supplied via maintenance bypass switch. No AC or DC supply is connected to the inside and the circuits of UPS.

### 4.2.4 Switching the UPS from a Maintenance Bypass Condition to Normal Operation

1. Turn on S1 (AC Input) switch (to “1” position).
2. Turn on S2 (Bypass) switch (to “1” position).
3. Turn on S4 (AC Output) switch (to “1” position).
4. Turn on S7 (On/Off) switch (to “1” position). LCD panel activates, and main menu will appear at the display. Also **“A08 ON MAINTENANCE”** message shown and the inverter will not start yet.
5. Turn off S3 (Maintenance Bypass) switch (to “0” position). Inverter will start automatically following the turning off of S3 switch.
6. Connect the batteries by turning on S5 (Battery) switch (to “1” position).

Now UPS is ready for uninterruptable operation.



---

---

### 4.3 UPS Behavior During Mains Outage

When the mains voltage is not available " **R02 LINE FAILURE** " message appears on LCD display. Sound warning on and off is heard at the same time. UPS continues to supply the critical loads by converting the battery voltage to AC voltage and provides operation without data losses or any other fault. Battery autonomy time may be prolonged by shutting down the unnecessary loads for that moment.

But do not turn on these loads again during battery operation.

After a short period of time when the line voltage is available again, UPS returns to normal operation automatically and the alarm message on the display disappears.

Shut down the critical loads in a period of minimum possible autonomy time (depends on the Ah capacity, charge status, age of the batteries, actual load percentage of UPS and the ambient temperature). Otherwise critical loads will be out of power at the end of battery autonomy time.

"**A26 BATTERY LOW**" message appears first on front panel display during battery operation if battery voltage drops below a defined level.

"**A10 BATTERY LOW SHUT**" message appears on front panel display when the battery voltage drops to the end of discharge voltage and UPS shuts itself down. Critical loads will be out of electrical power.

If a reserved generator in the system and if it's available, that will start to supply the necessary electrical power to UPS input and batteries start to be charged immediately. By means of using UPS together with a immediately available generator system, battery discharge time decreases and so they will be charged quickly after a mains outage.

## V. PARALLEL OPERATION

### 5.1 Introduction

Two (or more) identical DS300HT series UPSs can be interconnected for parallel operation. The main purposes for parallel use of DS300HT series UPSs are:

- Redundancy for Increased Reliability
- Power Increase

Although recent UPS designs are perfect and have high MTBF figures, a second (or more) UPS can be used in parallel with the first one, for supplying the critical load in case of any possible failure of the first UPS. In such an application the faulty UPS is isolated automatically from the parallel system and the other UPS (or UPSs) continues to supply the critical load. Use of Redundant UPSs in parallel, therefore, provides increased reliability for the critical load connected to the parallel system output.

If power demand increases in a certain UPS application exceeding the power rating of an already installed stand-alone UPS, a second (or more) UPS of the same model and power rating can be added in parallel to the existing UPS to increase the output power capacity.

Schematic diagram of parallel connection of two DS300HT series UPS units is shown in Figure 4.1

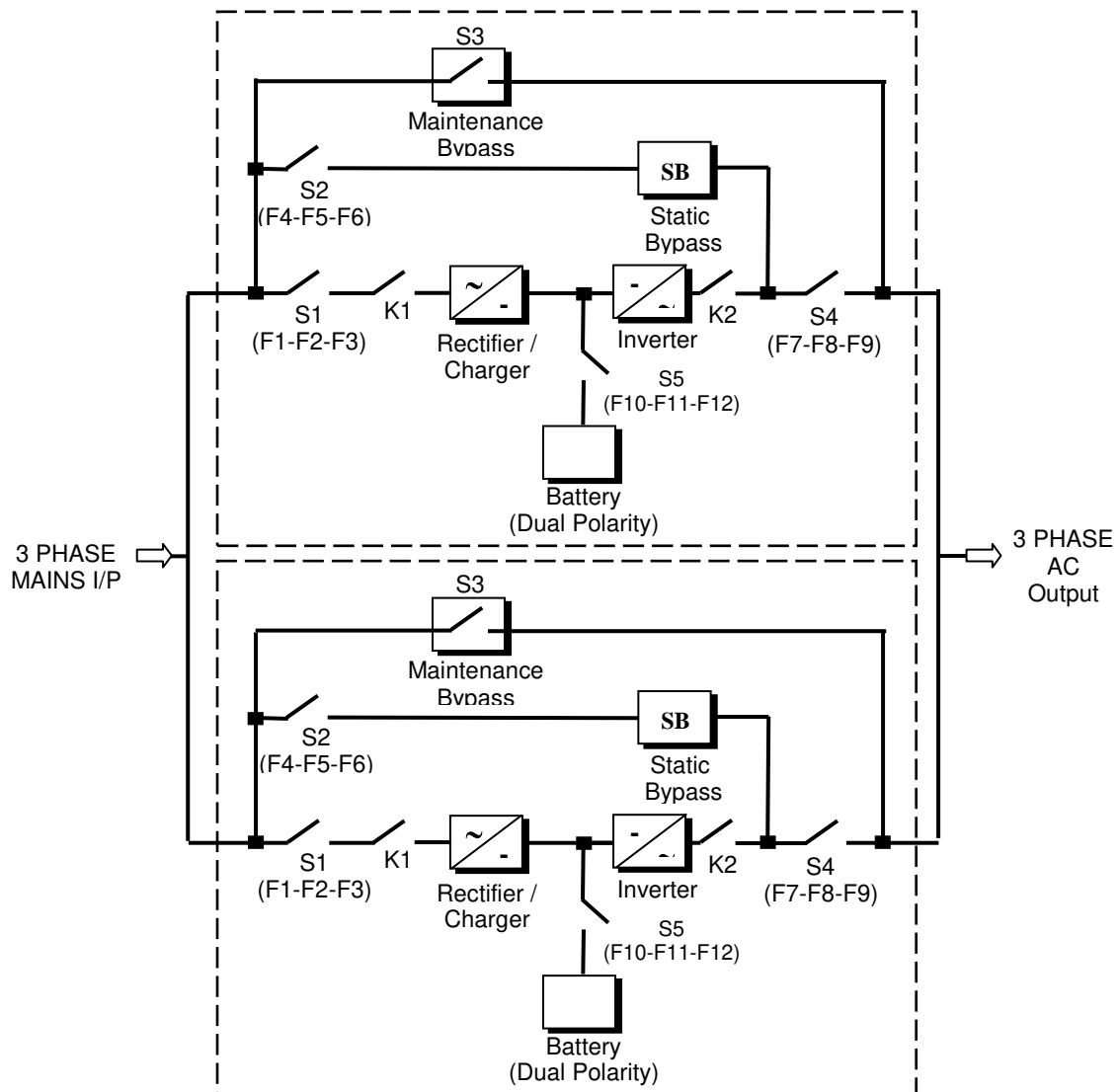

Figure 4.1 Parallel Connection of two UPSs

---

---

The AC inputs of all UPSs in the parallel system are connected to the same mains, and all the AC outputs are connected to each other. Each UPS has its own battery group. The critical load is connected to the common output of the parallel system. There are also some signal cable connections between the UPS units necessary for parallel operation, and will be described later.

## 5.2 Parallel Operation Mode settings of DS300HT Series UPSs

**NOTE: Parallel operation hardware (parallel communication board) are not installed in a standard DS300HT series UPS, but parallel operation option is available and can easily be added to all UPSs.**

N+1 REDUNDANT parallel operation

For parallel operation some parameters must be given by the service personnel these are:

- 1- Select Parallel mode must be selected from ADJUST MENU (ADJUST MENU/INV FACTORY OPTIONS/OPERATING MODE:)
- 2- A unique UPS network no must be given from ADJUST MENU(ADJUST MENU/INV FACTORY OPTIONS/UPS NO:) (each UPS must be assigned a unique UPS number)
- 3- Minimum UPS quantity requirement must be given from ADJUST MENU (ADJUST MENU/INV FACTORY OPTIONS/N+1 MINIMUM:.) (N number in the system)

Shown parameters can not be adjust by the user, these parameters are located on ADJUST MENU also adjust menu is password protected only authorized service personnel can access this menu.

### PARALLEL mode

This mode is used for operation of at least two (1+1 configuration) UPS units connected in parallel for increased reliability. If this mode is selected, the load is shared equally by each UPS available in the parallel system (N+1 numbers of UPS units), during normal operation.

In case of a failure of any one of the UPS units, the faulty UPS is isolated from the parallel system and the critical load is supplied by the remaining N number of UPSs. If any one of those UPS units fails too, then the critical load is transferred to bypass supply via the static bypass switches of the parallel connected UPSs. If the faulty UPS returns to normal operation, it joins the parallel system again and starts sharing the load.

**In parallel mode, the total VA rating of the parallel system is equal to the VA rating of a single UPS multiplied by N.**

In parallel mode, you will see "PARALLEL MODE /MS"(master UPS) or "PARALLEL MODE /sl" (slave UPS) message on the LCD panels of all the all UPS units.

More detailed diagrams for two (or more) DS300HT series UPSs connected in parallel are given in Figures 4.2 and 4.3

Communication between parallel UPSs are provided over one pair cable (PCC06). The length of the cable is limited up to six meters.

A link cable is used for connecting the first UPS to the last UPS ,this cable is redundant for normal communication cables.

If communication is lost on SLAVE UPS the UPS will shutdown but the MASTER UPS will go on running if the communication is provided at SLAVE UPS it will start automatically again.

**Figure 4.2** DS300HT Series Parallel UPS Signal Cable (PCC06) Connections

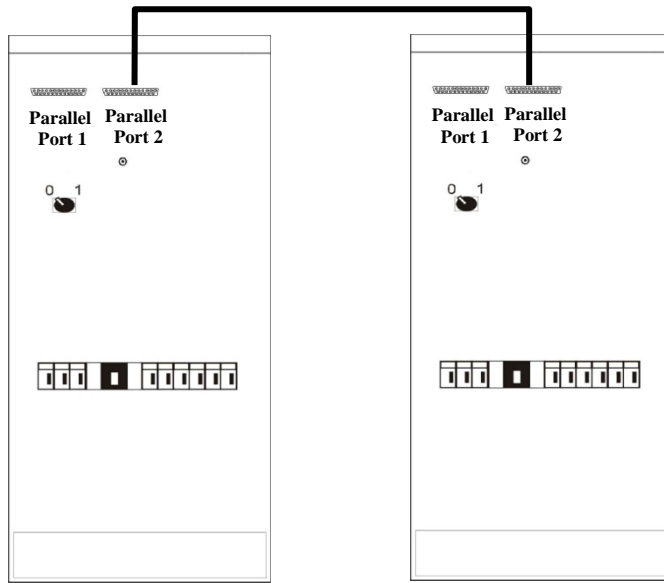

**Figure 4.2.a** 2 units in parallel if port2 jumper is

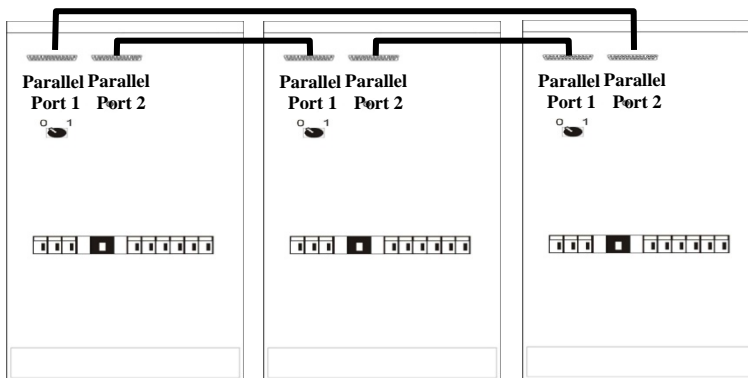

**Figure 4.2.b**  
3 units in parallel

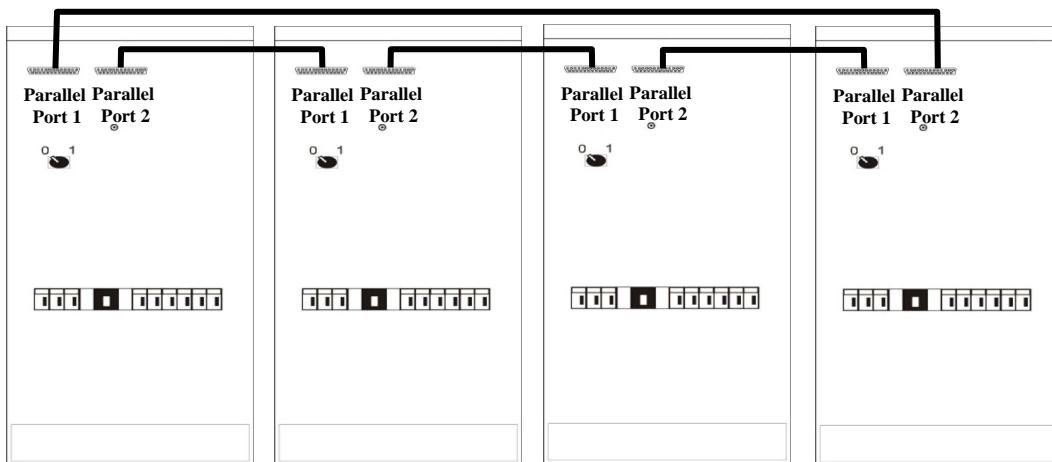

**Figure 4.2.c** 4 units in parallel

All the units must be set for the **same operation mode** and must have a **different UPS number**.

**CAUTION !!!** You must never set the operation modes of parallel connected UPS units to “ONLINE”, otherwise serious damage may occur in UPSs.

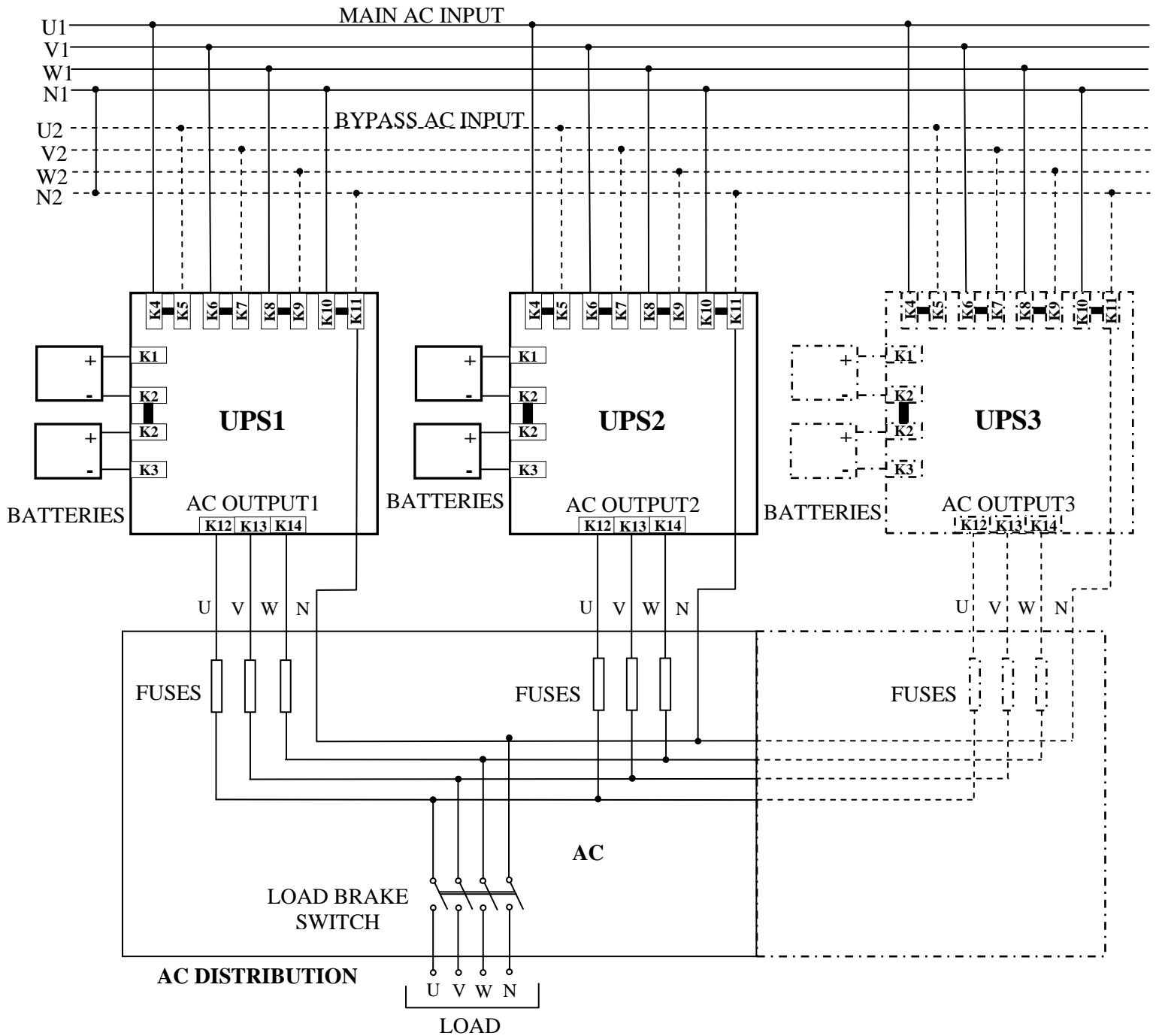

**Figure 4.3** DS300HT Series Parallel UPS Power Connections

**Note:** As seen in the figure, the outputs of parallel UPS units should be connected to each other using an AC distribution board.

---

---

## ATTENTION!!!

The cables from input distribution panel to the UPS by-pass input must be of the same size and length for proper bypass load sharing.

The cables from each UPS output to the load distribution panel must be of the same size and length for proper load sharing during parallel operation.

### 5.3 Parallel mode status codes of the UPS

#### 801 Status code

Status	Inverter system fault
Description	The UPS number of this UPS is same with MASTER UPS in parallel system
Restart	Change UPS number and Restart UPS again
Returning to fault	Directly fault

In parallel system each UPS must have a unique UPS number. If the UPS number is used in system ,the last UPS joined to parallel system produces this status code

#### 802 Status code

Status	Inverter system fault
Description	The Operation mode of this UPS is different with MASTER UPS in parallel system
Restart	Change operating mode and Restart UPS again
Returning to fault	Directly fault

In parallel UPS system master and slave UPS operating modes must be same

#### 803 Status code

Status	Inverter system fault
Description	Parallel Operation mode is selected but there is no paralleling board
Restart	Install parallel communication board and Restart UPS again
Returning to fault	Directly fault

#### 804 Status code

Status	Inverter system fault
Description	Parallel communication connector disconnected in slave mode inverter down
Restart	Connect parallel communication cable and Restart UPS again
Returning to fault	Directly fault

Check the followings

- Parallel or synchron mode selected but parallel data cable unplugged
- Call service

#### 805 Status code

Status	Inverter warning
Description	Parallel communication connector disconnected in master mode inverter continues to run
Restart	Connect parallel communication cable and wait
Returning to fault	--

Check the followings

- Parallel or synchron mode selected but parallel data cable unplugged
- Call service

<b>806 Status code</b>	
Status	Inverter system fault
Description	In parallel system SLAVE UPS started but the output voltage is not match to my inverter output voltage
Restart	Restart UPS again
Returning to fault	Directly fault

Check the followings

- Check the UPS nominal voltage ratings
- Call service

<b>807 Status code</b>	
Status	Inverter system fault
Description	In parallel system UPS decided to be master but there is AC voltage at the UPS output
Restart	Restart UPS again
Returning to fault	Directly fault

Check the followings:

- Turn off all UPSs in parallel system and restart again
- If the code is still showned call service

<b>820 Status code</b>	
Status	Inverter alarm
Description	In parallel system while in slave mode , MASTER communication lost for 8 periodes ,inverter stopped
Restart	Wait until UPS provide MASTER communication
Returning to fault	--
Fault code	--

<b>821 Status code</b>	
Status	Inverter alarm
Description	MASTER syncron failed while SLAVE UPS ,inverter stopped
Restart	Wait until UPS provide MASTER synchronization
Returning to fault	--
Fault code	--

<b>822 Status code</b>	
Status	Inverter alarm
Description	MASTER frequency exceeded minimum limit ,inverter stopped
Restart	If master frequency is okay automatic
Returning to fault	--

Check the followings:

- Check each UPS output frequency selection in parallel system

<b>823 Status code</b>	
Status	Inverter alarm
Description	MASTER frequency exceeded maximum limit ,inverter stopped
Restart	If master frequency is okay automatic
Returning to fault	--

Check the followings:

- Check each UPS output frequency selection in parallel system

824 Status code	
Status	Inverter alarm
Description	MASTER DC voltage zone 7, My DC voltage zone 1 inverter down
Restart	If mains input voltage is okay automatic
Returning to fault	--

Check the followings:

- Check the mains input power of the UPS
- If input power is OK wait until batteries are fully charged
- If the mains input power is shutdown check the other UPSs mains input power (in parallel system if the same A/H rating batteries are used at each UPS the battery discharge time be same for each UPS) If the other UPS is continue to run check the batteries of this UPS.
- Call service

825 Status code	
Status	Inverter alarm
Description	SLAVE DC voltage zone 7, My DC voltage zone 1 inverter down
Restart	If mains input voltage is okay automatic
Returning to fault	--

Check the followings:

- Check the mains input power of the UPS
- Check the battery status of this UPS
- Call service

826 Status code	
Status	Inverter alarm
Description	MASTER DC voltage zone 7, My DC voltage zone 1 trying to join system
Restart	If mains input voltage is okay automatic
Returning to fault	--

827 Status code	
Status	Inverter alarm
Description	SLAVE DC voltage zone 7, My DC voltage zone 1 trying to join system
Restart	If mains input voltage is okay automatic
Returning to fault	--

831 Status code	
Status	Inverter warning
Description	SLAVE UPS L1 phase output is not connected to load
Restart	--

<p>The diagram illustrates a parallel UPS configuration. On the left is the 'MASTER UPS' and on the right is the 'SLAVE UPS'. Both have three output lines. These lines are connected to a common bus that feeds three load phases: L1, L2, and L3. The L1 phase line from the SLAVE UPS is marked with a large 'X', signifying a fault or disconnection at that point.</p>	<p>Possible causes of this status code:</p> <ul style="list-style-type: none"> <li>-Check L1 phase UPS output fuse</li> <li>-Check L1 phase output switch LEG</li> <li>-Check the SLAVE UPS L1 phase output terminal for bad connection</li> <li>- Check the SLAVE UPS L1 phase output cable to load L1 phase</li> <li>- Call service</li> </ul>
-----------------------------------------------------------------------------------------------------------------------------------------------------------------------------------------------------------------------------------------------------------------------------------------------------------------------------------------------------------------------------	--------------------------------------------------------------------------------------------------------------------------------------------------------------------------------------------------------------------------------------------------------------------------------------------------------------------------------------------------



832 Status code	
Status	Inverter warning
Description	SLAVE UPS L2 phase output is not connected to load
Restart	--

831 Status code causes are valid for L2 phase

833 Status code	
Status	Inverter warning
Description	SLAVE UPS L3 phase output is not connected to load
Restart	--

831 Status code causes are valid for L3 phase

841 Status code	
Status	Inverter warning
Description	MASTER UPS L1 phase output is not connected to load
Restart	--

	<p>Possible causes of this status code:</p> <ul style="list-style-type: none"> <li>-Check L1 phase UPS output fuse</li> <li>-Check L1 phase output switch LEG</li> <li>-Check the SLAVE UPS L1 phase output terminal for bad connection</li> <li>-Check the SLAVE UPS L1 phase output cable to load L1 phase</li> <li>-Call service</li> </ul>
--	------------------------------------------------------------------------------------------------------------------------------------------------------------------------------------------------------------------------------------------------------------------------------------------------------------------------------------------------

842 Status code	
Status	Inverter warning
Description	MASTER UPS L2 phase output is not connected to load
Restart	--

841 Status code causes are valid for L2 phase

843 Status code	
Status	Inverter warning
Description	MASTER UPS L3 phase output is not connected to load
Restart	--

841 Status code causes are valid for L3 phase

850 Status code	
Status	Inverter warning
Description	MASTER UPS send by-pass transfer command
Restart	--
Returning to fault	--

<b>851 Status code</b>	
Status	Inverter warning
Description	MASTER UPS send transfer the load to UPS command
Restart	--
Returning to fault	--

<b>852 Status code</b>	
Status	Inverter warning
Description	Enter to sleep mode command received from parallel system
Restart	--
Returning to fault	--

<b>853 Status code</b>	
Status	Inverter warning
Description	Exit from sleep mode command received from parallel system
Restart	--
Returning to fault	--

<b>854 Status code</b>	
Status	Inverter warning
Description	REPO (remote emergency power off) command received from parallel system
Restart	--
Returning to fault	--

<b>855 Status code</b>	
Status	Inverter warning
Description	Enter to MASTER mode command received from parallel system
Restart	--
Returning to fault	--

<b>856 Status code</b>	
Status	Inverter warning
Description	UPS is currently in SLAVE mode ,MASTER function transferred to another UPS
Restart	--
Returning to fault	--

<b>857 Status code</b>	
Status	Inverter warning
Description	In parallel system there is no MASTER communication packages ,output switch turned on after 2 seconds MASTER mode started
Restart	--
Returning to fault	--

<b>858 Status code</b>	
Status	Inverter warning
Description	In parallel system there is no MASTER communication packages ,output switch turned on after 2 seconds MASTER mode started during on bypass
Restart	--
Returning to fault	--

<b>859 Status code</b>	
Status	Inverter alarm
Description	In parallel system transfer the load to maintenance bypass command received
Restart	--
Returning to fault	--

---

---

## VI. PARALLEL OPERATING INSTRUCTIONS

### 6.1 INTRODUCTION

After all the electrical connections of UPS have been made and while all the circuit breakers and switches of the device are turned OFF (at "0" position);

1. Check the polarities of battery connections:

- K1 : + V (nominal voltage +336V, float charge voltage +378V)
- K2-K2 : 0 V (common terminal for "+" and "-" battery groups)
- K3 : - V (nominal voltage -336V, float charge voltage -378V)

2. Check 3-phase AC input and neutral connections (care should be taken for the phase order).

**ATTENTION!!!** TWO CABLES FOR EACH BATTERY GROUP SHOULD BE USED FOR EXTERNAL BATTERY CONNECTION, AND THE COMMON POINT CONNECTION SHOULD BE MADE ON K2 TERMINAL BLOCK!

**WARNING !** : UPS should never be operated without neutral connection.

3. Check the output load connections of UPS.

### 6.2 OPERATING INSTRUCTIONS FOR PARALLEL CONNECTED UPSs.

#### 6.2.1 Starting UPSs from a completely shut down position:

1. Turn ON S1 (AC Input) switch (switch to "1" position)
2. Turn ON S2 (Bypass) switch (switch to "1" position)
3. Turn on S7 (On/Off) switch (to "1" position). LCD panel activates, and "INV RESET" or "PFC RESET" message appears on the display meaning that the rectifier starts to operate.
4. Turn ON S4 (AC Output) switch (switch to "1" position)
5. A few seconds later red bypass light (L2) on front panel turns off and green inverter light (L6) turns on. L6 light indicates that the UPS has started normal operation and generating uninterruptable power for the critical load.
6. Turn on S5 switch (to "1" position) to connect the battery group to UPS.
7. UPS is ready and in normal operation now.

#### 6.2.2 Shutting down the UPS

After closing all the critical loads supplied by the UPSs output:

1. Turn off S4 (AC Output) switch (to "0" position).
2. Turn off S7 (On/Off) switch (to "0" position).
3. Turn off S5 (Battery) switch (to "0" position).
4. Turn off S2 (Bypass) switch (to "0" position).
5. Turn off S1 (AC Input) switch (to "0" position).

After performing the above procedure, UPSs is completely shut-down. In this case PFC rectifier and inverter is not operating and the batteries are not being charged.

---

---

### 6.2.3 Switching the UPS from a Normal Operation to Maintenance Bypass Condition

1. Enter COMMANDS menu by using UP and DOWN buttons on front panel during normal operation. Select ENTER<BYPASS> command by using again the UP and DOWN buttons and pres ENTER button. The critical load is transferred to bypass supply in this case and it is shown at LCD display with **“A09 MANUAL BYPASS”** message. Besides L6 (load on UPS) light on front panel will be off and L2 light (bypass) will be on.
2. Turn on S3 (Maintenance Bypass) switch (after unlocking and taking away the padlock on it) to “1” position.
3. Turn off S7, S5, S1, S2 and S4 switches (to “0” position).

In this case, bypass voltage is connected directly to the output of UPSs and the critical load is supplied via maintenance bypass switch. No AC or DC supply is connected to the inside and the circuits of UPSs.

### 6.2.4 Switching the UPS from a Maintenance Bypass Condition to Normal Operation

1. Turn on S1 (AC Input) switch (to “1” position).
2. Turn on S2 (Bypass) switch (to “1” position).
3. Turn on S7 (On/Off) switch (to “1” position). LCD panel activates, and main menu will appear at the display. Also **“A08 ON MAINTENANCE”** message shown and the inverter will not start yet.
4. Turn on S4 (AC Output) switch (to “1” position).
5. Turn off S3 (Maintenance Bypass) switch (to “0” position). Inverter will start automatically following the turning off of S3 switch.
6. Connect the batteries by turning on S5 (Battery) switch (to “1” position).

Now UPSs is ready for uninterruptable operation.

---

---

## VII. MAINTENANCE

**ATTENTION !!!** There are no parts inside the UPS or battery group that needs service or maintenance work that should be done by user. Therefore DO NOT OPEN THE COVER OF UPS. Never touch on any terminal of battery group. There is risk of electric shock inside the UPS even when it is completely turned off (because of energy storage components). Therefore unauthorized opening of the UPS cabinet for repairment, maintenance etc. is not recommended and forbidden. Otherwise serious injuries may happen.

### 7.1 Scheduled Maintenance

Some parts and components used inside UPS requires periodic maintenance by service personnel. Besides, some power equipment inside the UPS need good air circulation for cooling functions. In this case, the UPS should be cleaned against dust periodically. Cooling fans are mechanical and moving parts and they should be checked periodically for this reason. Also the batteries should be checked periodically that if they are in good condition or not.

DS300HT Series UPS informs the user about these procedures when the maintenance time is up with its 3 independent hour counter as warnings:

**FAN MAINTENANCE counter**

**BATTERY MAINTENANCE counter**

**GENERAL MAINTENANCE counter**

This type of protective maintenance prevents small problems turning up to big failures.

**DS300HT Series UPS has been designed to require very low user maintenance work. User should only make below maintenance procedure for long years of trouble-free operation.**

### 7.2 Daily Checks

Observe the UPS daily and check the following:

Examine the operator control panel (front panel). Ensure that all LED indicators and parameter measurements are normal and there is no warning or alarm messages on LCD display.

Examine that there is any sign of overheating the UPS or not.

Check the rotation of cooling fans visually.

Check if there is a remarkable change in the sound of UPS or not.

Check if air inlets of the cabinet cooling system are not congested with dust or any other foreign object. Clean them with a vacuum cleaner if any present.

Take care not to leave any object on the UPS cabinet.

### 7.3 Weekly Checks

1. Examine the front panel and record the results.
2. Measure (from Measurements Menu) each of three phase voltages and record the values.
3. Measure (from Measurements Menu) UPS output current values and record the values.
4. Perform a Manual Battery Test (from Commands Menu) and check the status of the batteries.
5. Cabinet covers may be cleaned with a soft dampened (not wet) cloth.

---

---

Take notes if possible when you are examining the UPS. Compare the notes with previous ones and try to determine if there is a change or not. If there is a difference between the previous notes and the new ones, search for and record any new load added to UPS output between two records and the magnitude, place and type of the new load, if possible. This information may help to technical authority who will search for the cause of event in case of a failure.

If there is a remarkable difference between the records without any obvious reason, call technical service immediately.

#### **7.4 Annual Maintenance**

Annual maintenance by authorized service should be done at least two times a year in order to provide safe and efficient operation your UPS and battery group. UPS generates a warning message when the maintenance time has expired.

#### **7.5 Storage Conditions and Transportation of UPS**

- 1- Check battery charge status by performing a manual battery test before living the UPS in a storage place. If charge level is not high enough, leave the UPS for at least 12 hours to charge the batteries.
- 2- Disconnection of the cables should be done by an authorized service personnel.
- 3- Batteries should be recharged once every 6 months during storage.
- 4- Store the UPS and the batteries in a cool and dry place.  
Ideal storage temperature for UPS: 0 °C to 40 °C max.  
Ideal storage temperature for batteries: 10 °C to 35 °C max.
- 5- UPS should be fixed on its pallet for transporting. It should be carried by a forklift with its pallet.

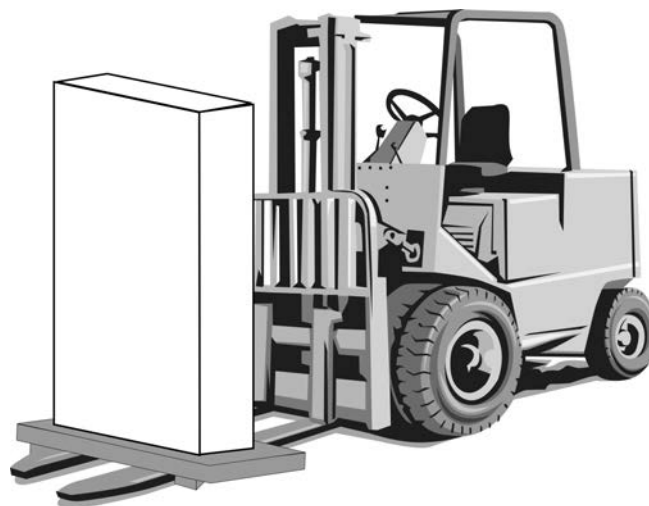

---

---

## VIII. FAULTS AND TROUBLESHOOTING

### 8.1 General Procedure For Fault Checking And Troubleshooting

UPS contains complicated electronic control circuits. In order to locate any fault occurring circuits, an advanced knowledge about the circuitry and its operation principles must be known. The aim of this section is to give the knowledge required at the first intervention.

There is no practical way to locate any possible fault. Most of the faults do not occur as a performance decrement. Generally, the UPS operates normally or switches into by-pass mode. But in order to determine any change in load or the system the parameters must be recorded regularly as mentioned previously.

Generally, the output voltage can deviate %2 from the predefined values. If values differ more than this percentage then reasons must be investigated.

The following general structure must be systematically followed while trying to indicate the error:

**Fault determination:** First step is to record the messages, indicator panel LEDs, operating parameter values and last status of switches. This must be done before

**Fixing interventions:** After recording all indications, check the meaning of the fault and alarm messages using "The operator control indicator panel". If anything related, follow the related procedure.

**Reporting the fault:** Service personal must clearly report the work done. Hence, if any other error occurs there will be enough information to fix it.

### 8.2 Before Calling Service

Please check and note the following:

- 1- Did you read the user manual carefully and applied the procedures accordingly?
- 2- Are the switches and circuit breakers of UPS in their normal position?
- 3- Is there electric power at the UPS line connection distribution panel?
- 4- Did you turn the battery switch on (to "1" position) when UPS started to operate in normal mode?
- 5- Which of the warning lights on front panel is (are) on?
- 6- Is there any change in the load level at the output of UPS?
- 7- Did any overload condition happen or not?

---

---

## IX. UPS REMOTE MONITORING AND CONTROL

Following external connections are available for DS300HT Series UPSs.

- Communication by serial port connection.
- Dry contact (interface board) connections.
- Remote monitoring panel.

Using one of above communication options is satisfactory for remote monitoring and control in most of the systems. But in some systems may use 2 or 3 of above options at the same time. In this case accessories group produced by Tescom may help to make appropriate solutions.

### 9.1 Using Serial Port

Two serial communication port is included on DS300HT Series UPS cabinet (com1 and com2). Both of them may be used for user communication. But in service status duty of com2 port is changed and set as service port in Options Menu.

All data of UPS can be accessed by this communication way. All the voltage and current values measured by UPS, alarms, warning and status messages can be monitored.

Because the communication system is designed in an interactive manner, UPS may get commands from monitoring and control units. These commands are listed below:

- Switch to BYPASS
- Switch to INVERTER
- SOUND on/off
- Adjust UPS time and date
- Quick BATTERY TEST
- BATTERY TEST until battery low alarm
- CANCEL battery test
- Turn off UPS output voltage immediately (SHUTDOWN)
- Turn off UPS output voltage after delay (WAITING SHUTDOWN)
- Turn off UPS output voltage (SHUTDOWN) and turn on UPS output voltage (WAITING RESTART)
- CANCEL SHUTDOWN
- RENAME UPS

These commands are evaluated only if **REMOTE CNTRL: ON** option is selected in **OPTIONS/COMMUNICATION OPTIONS** menu and if user password is sent from this (com2) port. Otherwise UPS doesn't perform these commands and only information can be obtained from the ports.

Special softwares are required in order to use the serial communication ports. Some of the commands above have special functions and they can only be activated and used by operating TMON program groups on a PC that is serially connected to UPS.

TMON program group includes softwares developed by TESCOM.

Additionally, remote monitoring and control is provided in every kind of operating systems, by using worldwide known and continuously developing software programs. These softwares can be supplied from TESCOM.

### 9.2 Serial Communication Port Connection Cable

The maximum length for RS232 communication cable should be 25 meters. For remote panel and UPS connection the same pin configuration is valid. Connection terminals of RS232 cable is shown below for com1 and com2 ports:

UPS Side	Panel Side
9 Tx	2 Rx
7 Gnd	5 Gnd
6 Rx	3 Tx

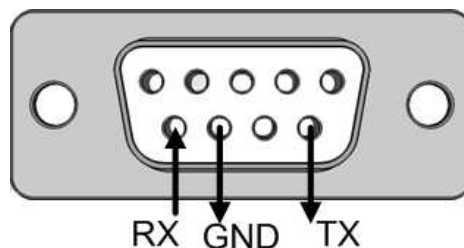



---

---

## 9.3 Modem Connection

A DS300HT Series UPS can be controlled through a normal telephone line by means of a remote operator connected through a PC with modem device, who performs a phone call to the UPS connected number. So the operator can see all parameters and control the UPS (if permitted from OPTIONS MENU).

### 9.3.1 Hardware Configuration

All requirements for modem connection are as follows:

- PC with modem
- WINDOWS 98
- Available UPS control software (T-MON)
- NULL modem which is connected to UPS

UPS has its command set to set NULL modem to auto answer mode. In order to do this, press ENTER button for 3 seconds in ENTER: MODEM INIT item in COMMAND MENU after the hardware is installed. A short beep sound warning is heard after pressing the button. RX and TX lights of the connected modem activates. Modem is set after this to answer external calls by telephone line. To test this, call the telephone number that the modem is connected with another phone and listen the modem sound.

**NOTE :** Not all the modems are compatible with the command set on UPS. In such a case modem should be set by connecting a PC.

### 9.3.2 Functioning Principle

The remote operator, by means of a PC and a modem device and using the remote connection function of the control software, calls the UPS through the number to which this is connected. The NULL modem device, connected to the UPS, will answer the call and convert the data coming from UPS's serial port on to the telephone line. This way all measurements and controls allowed by the RS232 serial port can be carried out.

### 9.3.3 Modem Programming Procedure

Smart modem (SM) is the one connected to PC, and NULL Modem (NM) is the one connected to the UPS. **Standard Hayes AT** programming language is the suitable language for modems. In usual applications a modem which uses AT command set should be selected.

#### 9.3.3.1 Smart Modem (SM) Programming

The connected modem to PC (smart modem) will be programmed from UPS control software (T-Mon) automatically.

```
B0 E1 F1 M1 Q0 V1 X3
BAUD = 2400 PARITY = N WORDLEN = 8
DIAL = TONE (TONE which can be programmed)
```

```
&A3 &B1 &C1 &D0 &H1 &I0 &K1 &M4
&N0 &R2 &S0 &T5 &Y1
```

### 9.3.4 Modem – UPS Connection Cable

Connection of Smart Modem device to UPS is made with standard modem cable and it's supplied as standard accessory for smart modem. This cable is required if an external modem will be used, and not necessary for internal modems.

Connection cable between NULL Modem and UPS should be installed as follows:

UPS DB9 Female	MODEM DB25 Male
6	3
7	7
9	2

### 9.4 Dry Contact (Interface) Connections

Some important events of the UPS can be monitored or controlled by these connections. These functions are listed below:

Terminal	
1-2	Interactive battery circuit breaker drive output or programmable alarm relay output
3-4	Interactive battery circuit breaker position sense input
5-6	Generator operation sense input
7-8	Remote Emergency Power Off button input (REPO)
9-10	External TH1 temperature sensor input
11-12	Function programmable relay contact output 2
13-14	Function programmable relay contact output 3
15-16	Function programmable relay contact output 4

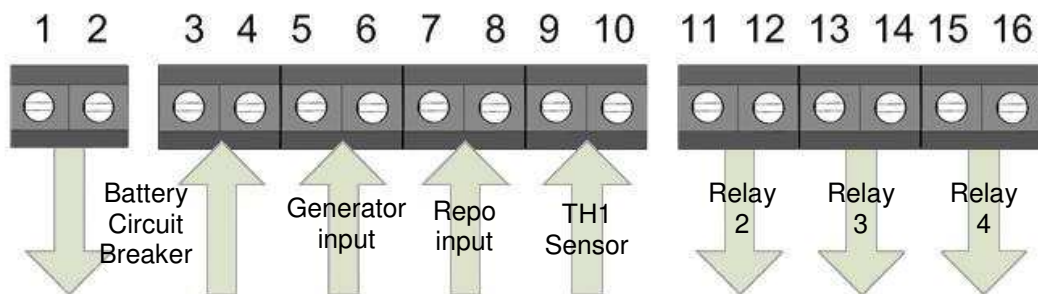

**ATTENTION:** Maximum 42Vac or 60Vac voltage may be applied to the dry contacts of the interface. Dry contact relay outputs are NO (Normally Open) type, ie. the relay is not activated if alarm is not present and the contacts are open circuit.

### 9.5 Remote Monitoring Panel Connection of UPS

This panel is used to control and monitor UPS remotely up to 400 m. distance from it. Panel is located in monitoring and control room. If the distance is not longer than 25 m. RS232, if longer RS485 communication protocol is used. RS485 requires additional adapter.

Remote monitoring panel communicates UPS in a serial way and transfers information to user. Remote panel requires 220Vac 50Hz supply voltage and it is recommended to get this supply from UPS output.

---

---

## **X. EFFICIENT USAGE OF UPS IN TERMS OF ENERGY CONSUMPTION**

Products should be used according to the conditions and procedures defined in the manual. When this is made the most efficient usage of the product is guaranteed.

**1.** Energy efficiency means, decreasing consumed energy amount to the minimum level possible in every step of living activities, without a decrease in quality or amount of produced work or product, and keeping this principle permanent.

An efficiency value is said in operation of every energy consuming device. Roughly, efficiency can be defined as the ratio of work or power -we obtain- at the output of a system, to that of -we give- at the input of same system.

Keeping below recommendations during the selection and operation of an electric powered product, provide more useful, economical and long-lasting usage in terms of energy efficiency. Therefore, user profits economically, as well as supporting to create a cleaner environment and protecting our world sources.

**2.** Every electric powered device is designed appropriate to a defined power level. Device capacity should be selected according to its load requirement for an efficient operation.

**3.** Ensure to operate your device in convenient electrical conditions defined in technical specifications table. It will work more efficiently in those conditions.

**4.** Check that operating environment is compatible to defined conditions.

**5.** Check if the place of installation is suitable as per the conditions mentioned in the relevant section of the manual.

**6.** By means of the periodically maintenance work, faulty or unefficient components of the device may be detected before the major failures. This results in more efficient operation and prevention of failures.

**7.** Usage of recyclable materials is one of a remarkable keys to more efficient energy consumption in total. Users should dispose the expired recyclable materials (batteries, electronic components etc.) according to local directions and laws.



AGKK14211 09/2021