



ONLINE UPS

MTI200 SERIES

20-200kVA

USER MANUAL

Safety Precautions

This manual contains information concerning the installation and operation of Modular UPS. Please carefully read this manual prior to installation.

The Modular UPS cannot be put into operation until it is commissioned by engineers approved by the manufacturer (or its agent). Not doing so could result in personnel safety risk, equipment malfunction and invalidation of warranty.

The UPS has been designed for commercial or industrial use only, and is not intended for use in any life support application. This is a CLASS C Uninterruptible Power Supply (UPS) product. In a domestic environment, this product may cause radio interference, in which case, the user may be required to take additional measures.



Compliance and standards

This product complies with CE73/23 & 93/68 (low voltage safety) and 89/336 (EMC), and the following UPS product standards:

*IEC62040-1-1-General and safety requirements for use in operator access area

*IEC/EN62040-2 EMC requirements CLASS C

*IEC62040-3 Performance requirements and test methods

For more details, refer to Chapter 9 . Continued compliance requires installation in accordance with these instructions and the use of manufacturer approved accessories only.



WARNING: high earth leakage current

Earth connection is critical before connecting the input supply (include both utility supply and battery).

"Earth leakage current introduced by the UPS, in any configuration from 10KVA to 200KVA, exceeds 3.5 mA and is less than 1000 mA and complies with the requirements of IEC/EN 62040-1 / IEC/EN 60950-1" Transient and steady-state earth leakage currents, which may occur when starting the equipment, should be taken into account when selecting instantaneous RCCB or RCD devices.

Residual Current Circuit Breakers (RCCBs) must be selected sensitive to DC unidirectional pulses (class A) and insensitive to transient current pulses.

Note also that the earth leakage currents of the load will be carried by this RCCB or RCD.

This equipment must be earthed in accordance with local electrical authority codes of practice.



WARNING: back feeding protection

This system has a control signal available for use with an automatic device, externally located, to protect against back feeding voltage through the mains Static Bypass circuit. If this protection is not used with the switchgear that is used to isolate the bypass circuit, a label must be added to the switchgear to advise service personnel that the circuit is connected to a UPS system.

The text has the following meaning or is equivalent to: Isolate the UPS before working on the circuit of this UPS.



Components that can be maintained by user

All the equipment maintenance and servicing procedures involving internal access need special tools and should be carried out only by trained personnel. The components that can only be accessed by opening the protective cover with tools cannot be maintained by user.

This UPS full complies with "IEC62040-1-1-General and safety requirements for use in operator access area UPS". Dangerous voltages are present within the battery box. However, the risk of contact with these high voltages is minimized for non-service personnel. Since the component with dangerous voltage can only be touched by opening the protective cover with a tool, the possibility of touching high voltage component is minimized. No risk exists to any personnel when operating the equipment in the normal manner, following the recommended operating procedures in this manual.



Battery voltage higher than 400Vdc

All the battery maintenance and servicing procedures involving internal access need special tools or keys and should be carried out only by trained personnel.

SPECIAL CARE SHOULD BE TAKEN WHEN WORKING WITH THE BATTERIES ASSOCIATED WITH THIS EQUIPMENT.

WHEN CONNECTED TOGETHER, THE BATTERY TERMINAL VOLTAGE WILL EXCEED 400Vdc AND IS POTENTIALLY LEATHAL.

Battery manufacturers supply details of the necessary precautions to be observed when working on, or in the vicinity of, a large bank of battery cells. These precautions should be followed implicitly at all times. Particular attention should be paid to the recommendations concerning local environmental conditions and the provision of protective clothing, first aid and fire-fighting facilities.

Contents

| | |
|---|----|
| Safety Precautions..... | 1 |
| Chapter 1 Installation | 1 |
| 1.1 Introduction..... | 1 |
| 1.2 Initial Checking..... | 1 |
| 1.3 Location | 1 |
| 1.3.1 UPS Location..... | 1 |
| 1.3.2 External Battery Room | 2 |
| 1.3.3 Storing | 2 |
| 1.4 Positioning | 2 |
| 1.4.1 System Cabinet..... | 2 |
| 1.4.2 Moving the Cabinets | 2 |
| 1.4.3 Clearances Required for Operating | 3 |
| 1.4.4 Front Access | 3 |
| 1.4.5 Final Positioning | 3 |
| 1.4.6 Installation of Adjustable Feet | 3 |
| 1.4.7 UPS Composition..... | 3 |
| 1.4.8 Installing Power Modules and Battery Modules | 5 |
| 1.4.9 Cable Entry | 6 |
| 1.5 External Protective Devices | 6 |
| 1.5.1 Rectifier and Bypass Input Supply of the UPS | 6 |
| 1.5.2 External Battery..... | 7 |
| 1.5.3 UPS Output..... | 7 |
| 1.6 Power Cables..... | 7 |
| 1.6.1 Cable Connections..... | 8 |
| 1.7 Control Cabling and Communication | 9 |
| 1.7.1 UPS Dry Contact GJ and Monitoring Board FK Features | 9 |
| 1.7.2 Dry Contact Interface of Battery and Environmental Temperature Detection..... | 9 |
| 1.7.3 Remote EPO Input Port | 10 |
| 1.7.4 Generator Input Dry Contact..... | 10 |
| 1.7.5 BCB Input Port..... | 11 |
| 1.7.6 Battery Warning Output Dry Contact Interface..... | 12 |
| 1.7.7 Integrated Warning Output Dry Contact Interface..... | 12 |
| 1.7.8 Mains Failure Warning Output Dry Contact Interface..... | 13 |
| Chapter 2 Battery Installation and Maintenance | 14 |
| 2.1 General Recommendations | 14 |
| 2.2 Battery Typologies | 15 |
| 2.2.1 Modular Battery Cabinet..... | 15 |
| 2.2.2 Traditional Battery Installation | 15 |
| 2.2.3 Modular Battery Pack Installation | 16 |
| 2.3 Modular Battery Maintenance..... | 16 |
| 2.4 Modular Battery Selection | 17 |
| Chapter 3 Installation of UPS Rack System and Parallel System..... | 18 |
| 3.1 Overview | 18 |
| 3.2 UPS Rack Modules in Parallel System | 18 |
| 3.2.1 Installation of Cabinet | 18 |
| 3.2.2 External Protective Devices..... | 18 |
| 3.2.3 Power Cables..... | 19 |

| | |
|--|----|
| 3.2.4 Parallel Signal Board | 19 |
| 3.2.5 Control Cables | 19 |
| Chapter 4 Installation Drawing | 20 |
| 4.1 Internal Battery Module | 27 |
| 4.1.1 Appearance of Internal Battery Module | 27 |
| Chapter 5 Operations | 29 |
| 5.1 Introduction | 29 |
| 5.1.1 Split-Bypass Input | 29 |
| 5.1.2 Static Transfer Switch | 30 |
| 5.2 1+1 Parallel System | 30 |
| 5.2.1 Features of Parallel System | 30 |
| 5.2.2 Parallel Requirements of UPS Modules | 30 |
| 5.3 Operating Mode | 31 |
| 5.3.1 Normal Mode | 31 |
| 5.3.2 Battery Mode | 31 |
| 5.3.3 Auto-Restart Mode | 31 |
| 5.3.4 Bypass Mode | 31 |
| 5.3.5 Cold Start Mode | 31 |
| 5.3.6 Maintenance Mode (Manual Bypass) | 31 |
| 5.3.7 Parallel Redundancy Mode (System Expansion) | 31 |
| 5.3.8 Eco Mode | 32 |
| 5.4 Battery Management—Set During Commissioning | 32 |
| 5.4.1 Normal Function | 32 |
| 5.4.2 Advanced Functions (Software Settings Performed by the Commissioning Engineer) | 32 |
| 5.5 Battery Protection (Settings by Commissioning Engineer) | 32 |
| Chapter 6 Operating Instructions | 33 |
| 6.1 Introduction | 33 |
| 6.1.1 Power Switches | 33 |
| 6.2 UPS Startup | 33 |
| 6.2.1 Start-Up Procedure | 33 |
| 6.2.2 Procedures for Switching Between Operation Modes | 34 |
| 6.3 Procedure for Switching the UPS between Maintenance Bypass and Normal Mode | 35 |
| 6.3.1 Procedure for Switching from Normal Mode to Maintenance Bypass Mode | 35 |
| 6.3.2 Procedure for Switching from Maintenance Mode to Normal Mode | 35 |
| 6.4 Procedure for Completely Powering Down a UPS | 36 |
| 6.5 EPO Procedure | 36 |
| 6.6 Auto Start | 36 |
| 6.7 UPS Reset Procedure | 36 |
| 6.8 Operation Instruction for Power Module Maintenance | 37 |
| 6.10 Language Selection | 37 |
| 6.11 Changing the Current Date and Time | 37 |
| 6.12 Control Password 1 | 38 |
| Chapter 7 Operator Control and Display Panel | 39 |
| 7.1 Introduction | 39 |
| 7.1.1 Mimic Current Path | 40 |
| 7.1.2 Audible Alarm (buzzer) | 40 |
| 7.1.3 Functional Keys | 40 |
| 7.1.4 Battery Pack Indicator | 41 |
| 7.2 LCD Display Type | 41 |
| 7.3 Detailed Description of Menu Items | 42 |

| | |
|---|----|
| 7.4 UPS Event Log..... | 44 |
| Chapter 8 Optional Parts | 47 |
| 8.1 Replacing Dust Filters..... | 47 |
| Chapter 9 Product Specification..... | 48 |
| 9.1 Applicable Standards..... | 48 |
| 9.2 Environmental Characteristics | 48 |
| 9.3 Mechanical Characteristics | 48 |
| 9.4 Electrical Characteristics (Input Rectifier)..... | 48 |
| 9.5 Electrical Characteristics (Intermediate DC Link)..... | 49 |
| 9.6 Electrical Characteristics (Inverter Output) | 49 |
| 9.7 Electrical Characteristics (Bypass Input) | 50 |
| 9.8 Efficiency | 50 |
| Appendix A Guide for Ordering and Selection of UPS Rack System..... | 51 |
| Appendix B. Split-Bypass Input Connection | 52 |

Table of Figures

| | |
|--|----|
| Fig.1- 1: UPS Structure | 5 |
| Fig.1- 2: Power Module Installation Diagram | 6 |
| Fig.1- 3: The Symbols of RCCB | 6 |
| Fig.1- 4: Bypass Module (Include Interface of Dry Contact Board GJ and Monitoring Board FK) | 9 |
| Fig.1- 5: Diagram of J2 and J3 Dry Contact of Temperature Detection | 9 |
| Fig.1- 6: Diagram of Input Dry Contact for Remote EPO | 10 |
| Fig.1- 7: Connection of Generator | 11 |
| Fig.1- 8: BCB Interface..... | 11 |
| Fig.1- 9: Battery Low Warning Dry Contact..... | 12 |
| Fig.1- 10: Integrated warning dry contact..... | 12 |
| Fig.1- 11: Utility Failure Warning Dry Contact | 13 |
| Fig.2- 1: Battery Box | 15 |
| Fig.2- 2: Diagram of Batteries Connection | 16 |
| Fig.3- 1: Circuit diagram of EPO..... | 18 |
| Fig.3- 2: Installation of Parallel Signal Board BJ | 19 |
| Fig.3- 3: Connection of Parallel Control Cables of “1+N” System | 19 |
| Fig.4- 1: Wiring Diagram..... | 20 |
| Fig.4- 2: External Battery Connection | 20 |
| Fig.4- 3: 60KVA UPS Built-in Battery Module System, Front and Rear View without Doors | 21 |
| Fig.4- 4: 200KVA UPS Module System, Front View and Rear View without Door..... | 21 |
| Fig.4- 5: 120KVA UPS Module System, Front View and Rear View without Door..... | 22 |
| Fig.4- 6: 60KVA UPS Module System, Front View and Rear View without Door..... | 22 |
| Fig.4- 7: 200KVA UPS External Dimensions | 23 |
| Fig.4- 8: 120KVA UPS External Dimensions | 24 |
| Fig.4- 9: 60KVA UPS External Dimensions | 24 |
| Fig.4- 10: 60KVA Built-in Battery UPS Module System External Dimensions | 25 |
| Fig.4- 11: Power Connection of Module System UPS..... | 26 |
| Fig.4- 12: Power Module | 26 |
| Fig.4- 13: Static Bypass Module..... | 27 |
| Fig.4- 14: Battery Module..... | 27 |
| Fig.5- 1: Single Unit Block Diagram | 29 |
| Fig.6- 1: Location of Battery Cold Start Button..... | 35 |
| Fig.7- 1: UPS operator control and display panel | 39 |
| Fig.7- 2: Main LCD Display | 41 |
| Fig.7- 3: Menu Tree Structure..... | 42 |
| Fig.8- 1: Dust Filter..... | 47 |
| Fig.B- 1: Split Bypass Connection of Modular System | 54 |

Table of Tables

| | |
|---|----|
| Table.1- 1: UPS Configuration List | 5 |
| Table.1- 2: Maximum Steady State AC and DC Current | 7 |
| Table.1- 3 Recommended sizes for power cables | 7 |
| Table.1- 4: Description of Input Dry Contact..... | 9 |
| Table.1- 5: Description of Input Dry Contact for Remote EPO | 10 |
| Table.1- 6: Description of Status Interface and Connection of Generator | 11 |
| Table.1- 7: Description of BCB Interface | 11 |
| Table.1- 8: Battery warning dry contact interface description | 12 |
| Table.1- 9: Integrated warning dry contact interface description..... | 13 |
| Table.1- 10: Description of Mains failure warning dry contact | 13 |
| | |
| Table.2- 1: Internal battery selection..... | 17 |
| Table.7- 1: Description of UPS Operator Control and Display Panel..... | 39 |
| Table.7- 2: Status Description of Indicator | 40 |
| Table.7- 3: Description of Audible Alarm..... | 40 |
| Table.7- 4: Functions of Functional Keys | 40 |
| Table.7- 5: Description of LCD Icons | 41 |
| Table.7- 6: Description of Items in UPS System Information Window | 42 |
| Table.7- 7: Item Description of UPS Menu..... | 43 |
| Table.7- 8: UPS Event List..... | 44 |
| Table.9- 1: Compliance with European and International Standards | 48 |
| Table.9- 2: Environmental Properties..... | 48 |
| Table.9- 3: Mechanical Properties..... | 48 |
| Table.9- 4: Rectifier AC Input (mains)..... | 48 |
| Table.9- 5: Battery Information..... | 49 |
| Table.9- 6: Inverter Output (to Critical Load)..... | 49 |
| Table.9- 7: Bypass Input | 50 |
| Table.9- 8: Efficiency, Air Exchange | 50 |

Chapter 1 Installation

1.1 Introduction

This chapter introduces the relevant requirements for positioning and cabling of the Modular UPS and related equipment. Because each site has its requirements, it is not the aim of this chapter to provide step-by-step installation instructions, but to act as a guide for the general procedures and practices that should be observed by the installing engineer.



Warning: installation can only be done by authorized engineers

Do not apply electrical power to the UPS equipment before the commissioning engineer arrives at installation site.

The UPS should be installed by a qualified engineer in accordance with the information contained in this chapter. All the equipment not referred to in this manual is shipped with details of its own mechanical and electrical installation information.



Phase 4-Wire Input Power is required

The standard UPS system can be connected to TN, TT AC distribution system (IEC60364-3) of 3-phase 4-wire, and a 3-wire to 4-wire conversion transformer is provided as an optional part.



WARNING: battery hazards

SPECIAL CARE SHOULD BE TAKEN WHEN WORKING WITH THE BATTERIES ASSOCIATED WITH THIS EQUIPMENT.

When connecting the battery, the battery terminal voltage will exceed 400Vdc and is potentially lethal.

- Eye protection should be worn to prevent injury from accidental electrical arcs.
- Remove rings, watches and all metal objects.
- Only use tools with insulated handles.
- Wear rubber gloves.
- If a battery leaks electrolyte, or is otherwise physically damaged, it must be replaced, stored in a container resistant to sulfuric acid and disposed of in accordance with local regulations.
- If electrolyte comes into contact with the skin, the affected area should be washed immediately with water.

1.2 Initial Checking

Perform the following checking operations prior to the UPS installation.

1. Visually examine if there is any damage inside and outside the UPS rack and battery equipment due to the transportation. Report any such damage to the shipper immediately.
2. Verify the product label and confirm the correctness of the equipment. The equipment label is attached on the back of front door. The UPS model, capacity and main parameters are marked on the label.

1.3 Location

1.3.1 UPS Location

The UPS is intended for indoor installation and should be located in a cool, dry and clean environment with adequate ventilation to keep the environmental parameters within the specified operating range (see *Table.9-2*).The Modular series UPS uses forced convection cooling by internal fans. Cooling air enters the module through ventilation grills located at the front part of the cabinet and exhausted through grills located in the rear part of the cabinet. Please do not block the ventilation holes.

If necessary, a system of extractor fans should be installed to aid cooling-air flow. An air filter should be used when the UPS is to operate in a dirty environment and should be regularly cleaned to maintain airflow. The cooling capacity of air conditioner should be selected according to the power loss data of UPS specified in *Table.9-8*: Normal mode (VFI SS 111 double-conversion UPS)

Note: The UPS should be installed on a cement surface or other surface that is not combustible.

1.3.2 External Battery Room

The battery will generate some amount of hydrogen and oxygen at the end of charging, so the fresh air volume of the battery installation environment must meet EN50272-2001 requirements.

The ambient temperature of the battery must be stable. Ambient temperature is a major factor in determining the battery capacity and life. The nominal operating temperature of battery is 20°C. Operating above this temperature will reduce the battery life, and operation below this temperature will reduce the battery capacity. If the average operating temperature of battery is increased from 20°C to 30°C, then the service life of the battery will be reduced by 50%. If the operating temperature of the battery is above 40°C, then the battery service life will be decreased in exponent rate. In a normal installation, the battery temperature is maintained between 15°C and 25°C. Keep batteries away from heat sources or air outlets.

If external batteries are to be used, the battery circuit breakers (or fuses) must be mounted as close as possible to the batteries, and the connecting cables should be as short as possible.

1.3.3 Storing

Should the equipment not be installed immediately, it must be stored in a room so as to protect it against excessive humidity and heat sources (see *Table.9-2*).The battery needs to be stored in dry and cool place with good ventilation. The most suitable storage temperature is 20 °C to 25°C.



Warning battery deep discharge

Should the UPS remains unpowered for a prolonged period of time while the battery are connected, the batteries may deeply discharge and being so permanently damaged .In such cases it is therefore recommended to leave the battery circuit breaker(s) open. During storage in any case, periodically charge the battery according to the battery user manuals.

1.4 Positioning

When the equipment has been finally positioned, ensure the UPS will remain stationary and stable. To prolong the service life, the place chosen must guarantee:

- Space for easy operation on the UPS
- Air sufficient enough to dispel heat produced by UPS
- Against atmospheric agents
- Against excessive humidity and heat sources
- Against dust
- With the current fire prevention requirements
- The operating environment temperature is within +20°C to +25°C. The batteries are at maximum efficiency in this temperature range (for information about the battery storage and transportation as well as the environment, refer to *Table.9-2*)
- This equipment is of steel frame structure wrapped by removable panels. The top and side panels are fixed by screws.
- After opening the UPS rack door, the auxiliary connections for external low voltage interface and the maintenance bypass can be accessed. The UPS rack has an operator and control panel located on its front door, which provides the basic operating status and alarm information. Batteries are external. The UPS provides air inlet port in the front and the air exhaust port in the rear part.

1.4.1 System Cabinet

A UPS system can comprise an UPS rack system, external battery cabinet, depending on the specific system requirement. All the UPS system cabinets used in the same installation site are of the same height and should be positioned side-by-side to achieve an aesthetically appealing effect. Refer to Chapter 7 Installation Drawing for the positioning of UPS cabinet.

1.4.2 Moving the Cabinets



Ensure that any lifting equipment used in moving the UPS cabinet has sufficient lifting capacity. The UPS is fitted with castors – take

care to prevent movement when unbolting the equipment from its shipping pallet. Ensure adequate personnel and lifting aids are available when removing the shipping pallet.

Ensure that the UPS weight is within the weight loading capacity range of any hoisting equipment. See *Table.9-3* for UPS weight.

UPS and optional cabinets can be handled by means of a fork lift or similar equipment. The UPS cabinet can also be moved by its castors when moving in a short distance.

Note: Care must be taken when handling units fitted with batteries. Keep such moves to a minimum.

1.4.3 Clearances Required for Operating

As rack module UPS has no ventilation grills at either sides, no clearances are required for the sides.

To enable routine tightening of power terminations within the UPS, it is recommended that clearance around the front of the equipment should be sufficient to enable free passage of personnel with the doors fully opened. It is important to leave a distance of 500mm in the rear side of the rack to permit adequate circulation of air coming out of the unit.

If the UPS make use of internal modular battery sufficient clearing shall be given at the back site to allow personnel to operate the battery circuit breakers

1.4.4 Front Access

The component layout of the UPS rack system supports front access and repairing the UPS, thus reducing the space requirement for side access.

1.4.5 Final Positioning

When the equipment has been finally positioned, ensure the adjustable feet are set so that the UPS will remain stationary and stable.

1.4.6 Installation of Adjustable Feet

Installation diagrams in Chapter 4 of this manual identify the location of the holes in the base plate through which the equipment can be bolted to the floor. If the UPS is to be located on a raised floor, it should be mounted on a pedestal suitably designed to accept the UPS point loading (more than 800 kg).

1.4.7 UPS Composition

The UPS structure is shown in *Fig. 1-1*. The UPS configuration is provided in *Table. 1-1*

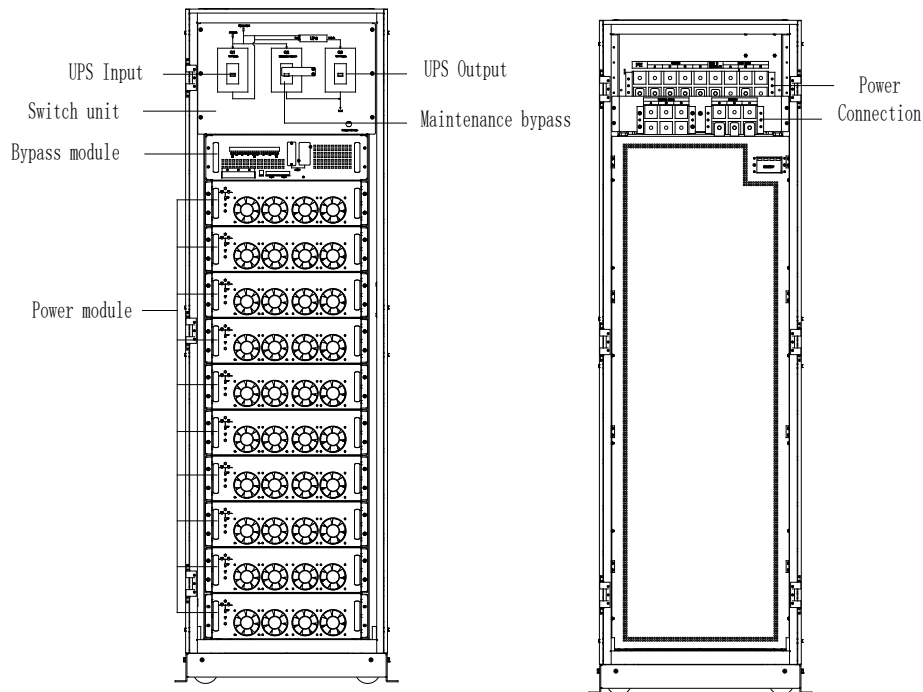

(a) 10 module cabinet

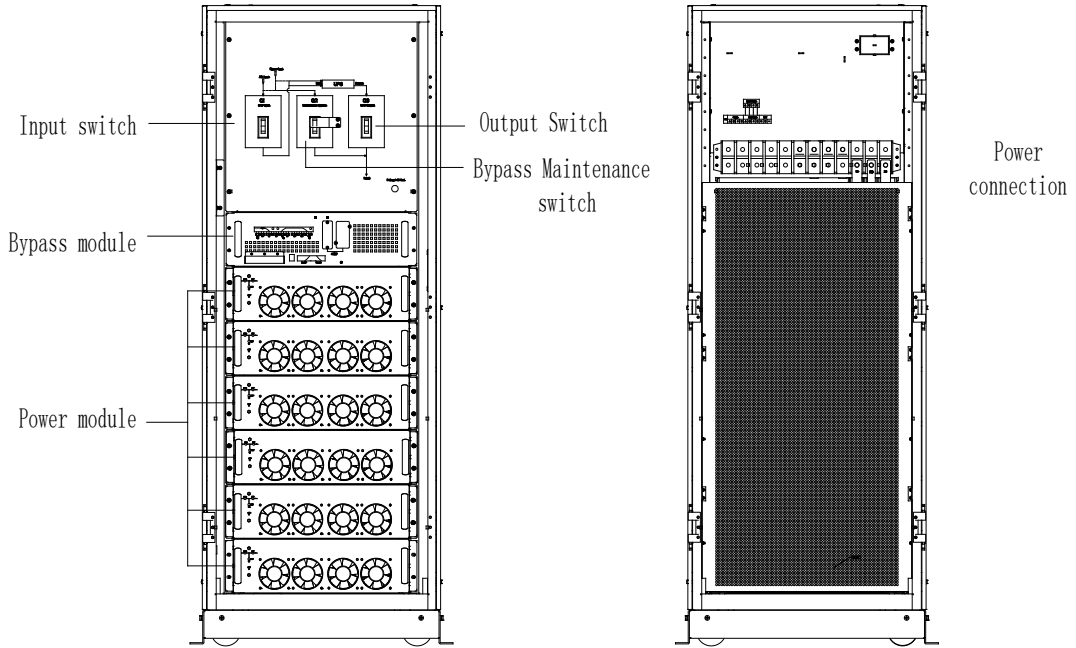

(b) 6 module cabinet

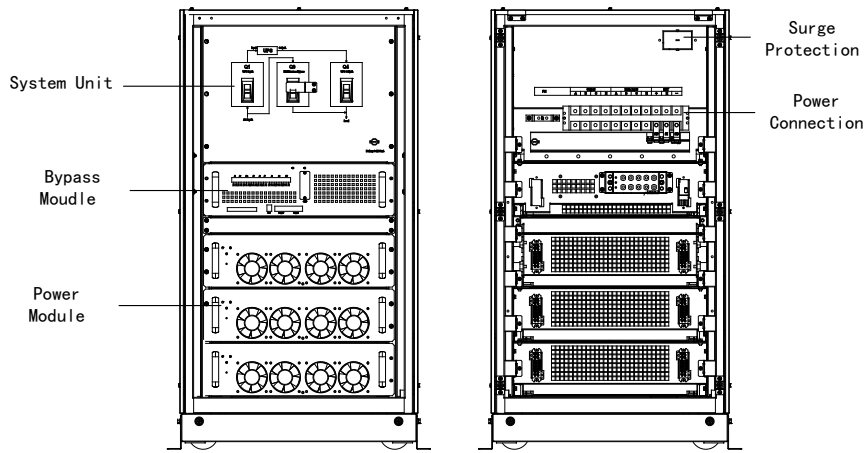

(c) 3 module cabinet

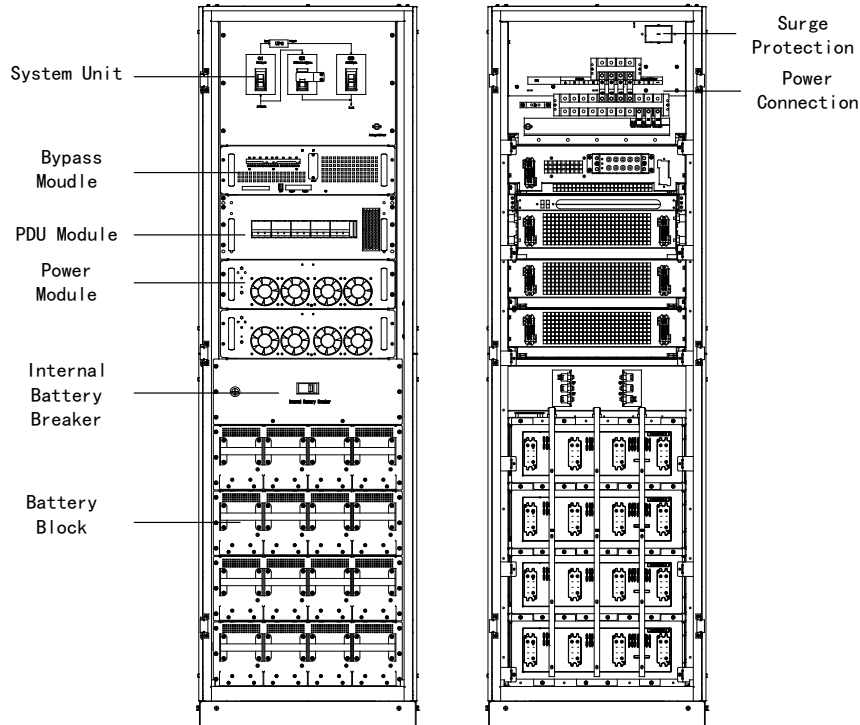

(d) 3 module cabinet including battery packs inside

Fig.1- 1: UPS Structure

Table.1- 1: UPS Configuration List

| Item | Component | Quantity | Remarks |
|------|--|--------------------|---|
| 1 | System Display | 1 | Requisite, factory installed |
| 2 | Bypass module | 1 | Requisite, factory installed |
| 3 | Input/output/maintenance bypass breakers | 1 | Requisite, factory installed |
| 4 | Power module | $1 \leq n \leq 10$ | Requisite |
| 5 | Battery module | 0~16 | Optional. Only available for battery inside model |
| 6 | PDU module | 1 | Optional, 1~32A, 15 output. Available for battery inside model or 60KVA model |
| 7 | Battery breaker | 1 | Requisite. Only available for battery inside model |

1.4.8 Installing Power Modules and Battery Modules

The number and possible installation positions of the Power Modules and Battery Modules may vary according to the chosen factory configuration. Thanks to the different mounting depth it's not possible to install a power module instead of a battery module and vice versa.

Please install the power modules and Battery modules from bottom to top, so as to avoid cabinet toppling due to high gravity center.

Installation procedures of power modules

When installing power modules always work from the lower available space upwards to prevent from raising the center of gravity. The default setting from the bottom space upwards is NO.1 to NO.10 (10 modules cabinet), NO.1 to NO.6 (6 modules cabinet), or NO.1 to NO.3 (3 modules cabinet or battery inside model).

Insert the module in the installation position, and push it into the cabinet.

Secure the module to the cabinet through the fixing holes on both sides of the front panel of the module.

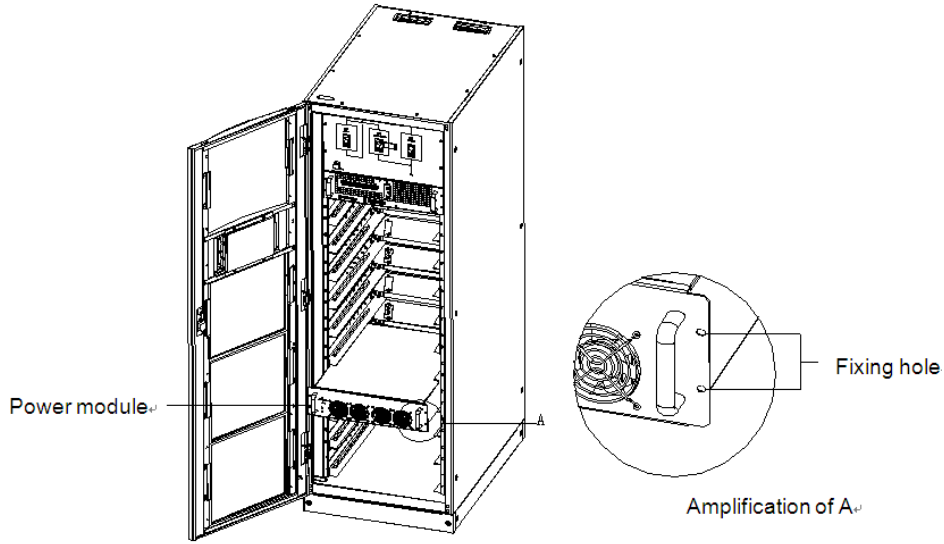

Fig.1- 2: Power Module Installation Diagram

Installation procedures of Battery Modules

When installing battery modules always work from the lower available space upwards to prevent raising the center of gravity.

1. Open the front door
2. Insert the module in the installation position, and push it into the cabinet.
3. Secure the module to the cabinet trough the fixing holes on both side of the front panel of the module

1.4.9 Cable Entry

Cables can enter the module UPS rack system and battery cabinet both from bottom and top. Cable entry is made possible through a blanking plate fitted at the bottom or top of the equipment. The recommended installation practice is to install glands to prevent foreign material or vermin entering the cabinet.

1.5 External Protective Devices

For safety concerns, it is necessary to install external circuit breakers or other protective devices for the input AC supply of the UPS system. This section provides generic practical information for qualified installation engineers. The installation engineers should have the knowledge of the regulatory wiring standards, and of the equipment to be installed.

1.5.1 Rectifier and Bypass Input Supply of the UPS

Over currents

Install suitable protective devices in the distribution unit of the incoming mains supply, considering the power cable current-carrying capacity and overload capacity of the system (see Tab. 9-7). Generally, the magnetic circuit breaker with IEC60947-2 tripping curve C (normal) at the 125% of the current listed in Tab. 9-7 is recommended. Split bypass: In case a split bypass is used, separate protective devices should be installed for the rectifier input and bypass input in the incoming mains distribution panel.

Note: The rectifier input and bypass input must use the same neutral line.

Protection against earth faults (RCD devices):

The RCD device installed upstream of the input supply should:

Sensitive to DC unidirectional pulses (class A) in the network

Insensitive to transient current pulses

Have an average sensitivity that is adjustable between 0.3A and 1A.

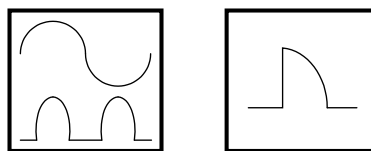

Fig.1- 3: The Symbols of RCCB

When using the RCD in the split bypass system or parallel system, the RCD should be installed in the upstream of the input distribution to avoid wrong alarm.

The residual current introduced by RFI filter in the UPS is between 3.5mA and 1000mA. It is recommended to confirm the sensitivity of each RCD of upstream input distribution and downstream distribution (to load).

1.5.2 External Battery

The DC compatible circuit breaker provides over current protection for UPS system and battery, which is provided by the external battery cabinet.

1.5.3 UPS Output

In the eventuality that an external distribution panel is used for load distribution, the selection of protective devices must provide discrimination with those that are used at the input to the UPS (see Tab. 9-7).

1.6 Power Cables

Design the cables according to the descriptions in this section and local regulatory wiring standards, and the environmental conditions (temperature and physical support media) should be taken into consideration. Refer to IEC60950-1 Table 3B Cabling.

| |
|---|
|  WARNING |
| FAILURE TO FOLLOW ADEQUATE EARTHING PROCEDURES CAN RESULT IN EMI, ELECTRIC SHOCK HAZARD, OR RISK OF FIRE, SHOULD AN EARTH FAULT OCCUR. |

Table.1- 2: Maximum Steady State AC and DC Current

| UPS power(KVA) | Rated current (A) | | | | | | | | |
|----------------|--|------|------|--|------|------|--|-----------------|-----------------|
| | Main input current at full load battery charging ^{1, 2} | | | Output current at full load ² | | | Battery discharging current at E.O.D=1.67V/cell, no overload | | |
| | 380V | 400V | 415V | 380V | 400V | 415V | 36 Batt./string | 38 Batt./string | 40 Batt./string |
| 200 | 346 | 329 | 317 | 303 | 288 | 277 | 524 | 497 | 472 |
| 120 | 208 | 197 | 189 | 182 | 173 | 166 | 315 | 298 | 284 |
| 100 | 173 | 164 | 158 | 152 | 144 | 139 | 262 | 248 | 236 |
| 60 | 103 | 99 | 94 | 91 | 87 | 83 | 157 | 149 | 142 |
| 40 | 69 | 66 | 63 | 61 | 58 | 56 | 105 | 99 | 95 |
| 30 | 52 | 50 | 48 | 46 | 43 | 42 | 79 | 75 | 71 |
| 20 | 34 | 33 | 32 | 30 | 29 | 28 | 52 | 50 | 47 |

Table.1- 3 Recommended sizes for power cables

| Capacity | 30kVA | 45kVA | 60kVA | 90kVA | 100kVA | 120kVA | 150kVA | 200kVA |
|--|-------|-------|-------|-------|--------|--------|--------|--------|
| Main input (mm ²) | 10 | 25 | 25 | 35 | 50 | 50 | 70 | 95 |
| Bypass input (Optional)(mm ²) | 10 | 25 | 25 | 35 | 50 | 50 | 70 | 95 |
| Output(mm ²) | 10 | 25 | 25 | 35 | 50 | 50 | 70 | 95 |
| Battery(mm ²) | 16 | 25 | 35 | 50 | 50 | 70 | 70 | 95 |
| PE(mm ²) | 25 | 35 | 35 | 50 | 50 | 50 | 70 | 70 |

Note:

1. Input current of common input configurations of rectifier and bypass
2. Take special care when determining the size of the output and bypass neutral cable, as the current circulating on the neutral cable may be greater than nominal current in the case of non-linear loads, which is usually 1.732 times of rated currents.
3. The earth cable connecting the UPS to the main ground system must follow the most direct route possible. The earth conductor

should be sized according to the fault rating, cable lengths, type of protection, etc.

According to AS/IEC60950-1, the cross section area of the conductor is 95mm² (200kVA), the cross section area of the conductor is 50mm² (120KVA).

4. When sizing battery cables, a maximum volt drop of 4Vdc. is permissible at the current ratings given in Table.1-2. The load equipment is connected to a distribution network of individually protected busbars fed by the UPS output rather than connected directly to the UPS. In parallel multi-module systems, the output cable of each ups rack unit should be kept at equal length between the output of the ups rack output terminals and the parallel distribution busbars to avoid affecting the shared current. When laying the power cables, do not form coils, so as to avoid the formation of electromagnetic interference.

5. See Chapter 4 Installation Drawing for the positions of wiring terminals.

| |
|---|
|  WARNING |
| FAILURE TO FOLLOW ADEQUATE EARTHING PROCEDURES CAN RESULT IN EMI, ELECTRIC SHOCK HAZARD OR RISK OF FIRE, SHOULD AN EARTH FAULT OCCUR. |

1.6.1 Cable Connections

| |
|--|
|  |
| The operations described in this section must be performed by authorized electricians or qualified technical personnel.. If you have any difficulties, do not hesitate to contact our Customer Service & Support department. |

After the equipment has been finally positioned and secured, refer to Chapter 4 Installation Drawing to connect the power cables as described in the following procedures:

1. Verify that all the external input distribution switches of the UPS are completely opened and the UPS internal maintenance bypass switch is opened. Attach necessary warning signs to these switches to prevent unauthorized operation.
2. Open rear panel of the UPS, and then the power connection terminals are visible.
3. Connect the protective earth and any necessary grounding cables to the PE terminal. The cabinet for the UPS must be connected to the user's ground connection.

Note: The grounding cable and neutral cable must be connected in accordance with local and national codes practice.

Identify and make power connections for incoming cables according to one of the two procedures below, depending on the type of installation:

| |
|---------------------------------|
| Common Input Connections |
|---------------------------------|

4. For common bypass and rectifier inputs, connect the AC input supply cables to the UPS input terminals (input A-B-C-N) Refer to Fig. 4-11 and tighten the connections to 5 Nm (M6 Bolt), 13Nm(M8 Bolt) or 25Nm (M10 Bolt). ENSURE CORRECT PHASE ROTATION.

| |
|---|
| Split Bypass Connections(option) |
|---|

5. If a 'split-bypass' configuration is used, connect the AC input supply cables to the rectifier input terminals (input A-B-C-N) Refer to Fig.4-11 and the AC bypass supply cables to the bypass input terminals (bypass A-B-C-N) and tighten the connections to 5 Nm (M6 Bolt) or 13Nm (M8 Bolt) or 25Nm (M10 Bolt). ENSURE CORRECT PHASE ROTATION.

Note: For split Bypass operation ensure that the busbars between Bypass and Rectifier inputs are removed. The neutral line of bypass input must be connected to that of the rectifier input.

| |
|---------------------------------|
| Frequency Converter Mode |
|---------------------------------|

If the frequency converter configuration is used, connect the AC input cables to the rectifier input terminals (input A-B-C-N) Refer to Fig.4-11 and tighten the connections to 5Nm (M6 bolt), or to 13Nm (M8 bolt), or to 25Nm (M10 bolt). ENSURE CORRECT PHASE ROTATION AND TIGHTEN CONNECTION TERMINALS. No need to connect the bypass input cables to bypass input terminals (bA-bB-bC-bN).

Note: For the frequency converter operation mode, ensure that the busbars between Bypass and Rectifier inputs are removed.

| |
|----------------------------------|
| Output System Connections |
|----------------------------------|

6. Connect the system output cables between the UPS output busbars (output A-B-C-N) Refer to Fig.4-11 and the critical load and tighten the connections to 5Nm (M6 Bolt) or to 13Nm (M8 Bolt) or to 25Nm(M10 Bolt). ENSURE CORRECT PHASE ROTATION.

| |
|--|
|  WARNING |
| If the load equipment will not be ready to accept power on the arrival of the commissioning engineer, then ensure that the system output cables are safely isolated at their ends. |

7. Re-install all the protective covers.

1.7 Control Cabling and Communication

1.7.1 UPS Dry Contact GJ and Monitoring Board FK Features

According to the specific needs of the field, the UPS may need auxiliary connection to realize the management of the battery system (including external battery switch and battery temperature sensor), communicate with PC, provide alarm signal to external device, or realize remote EPO. These functions are realized through the UPS dry contact board (GJ) and monitoring board (JK) at the front of bypass module. The boards provide the following interfaces:

- EPO
- Environment and battery temperature input interface
- Generator input dry contact interface
- Battery warning output dry contact interface
- Battery circuit breaker interface
- Mains failure warning output dry contact interface
- Intelligent card interface
- User communication interface

The UPS dry contact board GJ provides input dry contacts and output dry contacts.

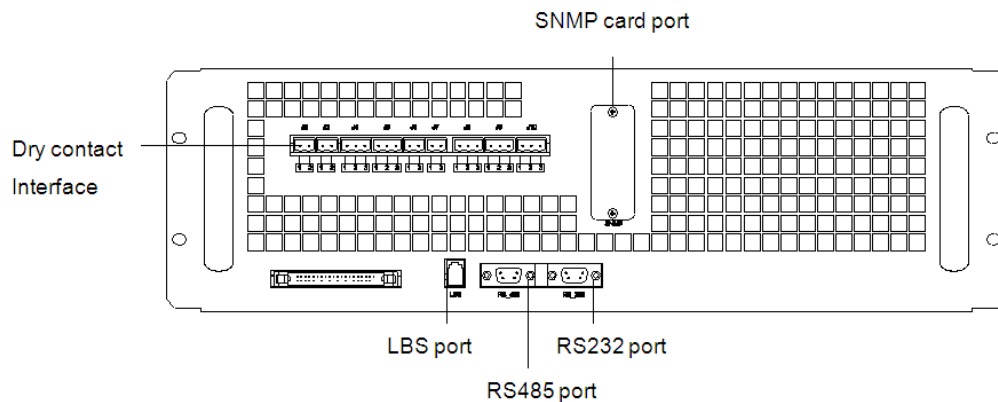

Fig.1- 4: Bypass Module (Include Interface of Dry Contact Board GJ and Monitoring Board FK)

1.7.2 Dry Contact Interface of Battery and Environmental Temperature Detection

The input dry contact J2 and J3 detect the temperature of batteries and environment respectively, which can be used in environment monitoring and battery temperature compensation.

J2 and J3 interfaces diagram are shown in *fig.1-5*, the description of interface is in *table.1-3*.

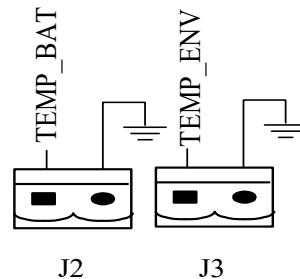

Fig.1- 5: Diagram of J2 and J3 Dry Contact of Temperature Detection

Table.1- 4: Description of Input Dry Contact

| Position | Name | Purpose |
|----------|----------|-----------------------------------|
| J2.1 | TEMP_BAT | Battery temperature detection |
| J2.2 | / | Battery temperature detection |
| J3.1 | TEMP_ENV | Environment temperature detection |

| Position | Name | Purpose |
|----------|----------|-----------------------------------|
| J2.1 | TEMP_BAT | Battery temperature detection |
| J2.2 | / | Battery temperature detection |
| J3.1 | TEMP_ENV | Environment temperature detection |
| J3.2 | / | Environment temperature detection |

Note: Specified temperature sensor is required for temperature detection (R25=50hm, B25/50=3275), please confirm with the manufacturer, or contact local maintenance engineers when placing an order.

1.7.3 Remote EPO Input Port

The UPS has an Emergency Power OFF (EPO) function. This function can be activated by pressing a button on the control panel of the UPS or through a remote contact provided by the user. The EPO pushbutton is protected by a hinged plastic cover.

J4 is the input port for remote EPO. It requires shorting NC and +24v during normal operation, and the EPO is triggered when opening NC and +24v, or shorting NO and +24v. The port diagram is shown in *fig.1-6*, and port description is shown in *table.1-4*.

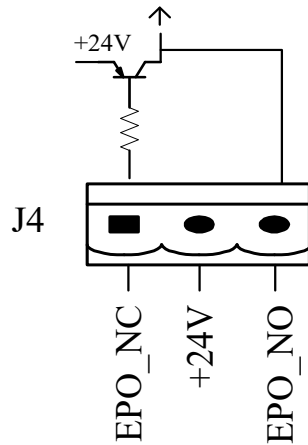

Fig.1- 6: Diagram of Input Dry Contact for Remote EPO

Table.1- 5: Description of Input Dry Contact for Remote EPO

| Position | Name | Purpose |
|----------|--------|--|
| J4.1 | EPO_NC | EPO is activated when disconnecting from J4.2 |
| J4.2 | +24V | +24V, connect the common terminal of NC and NO |
| J4.3 | EPO_NO | EPO is activated when shorting with J4.2 |

The EPO is triggered when shorting pin 2 and 3 or opening pin 2 and 1 of J4.

If an external emergency stop facility is required, it is connected via the reserved terminals of J4. The external emergency stop facility needs to use shielded cables to connect to the normally open/closed remote stop switch between these two pins. If this facility is not used, then pin 3 and pin 4 of J4 must be open, or pin 1 and pin 2 of J4 must be shorted.

1. The emergency stop action within the UPS will shut down the rectifier, inverter and static bypass. However, it does not internally disconnect the mains input power supply. To disconnect ALL power to the UPS, open the upstream input circuit breaker(s) when the EPO is activated.
2. Pin 1 and 2 of J4 have been shorted before the UPS is delivered.
3. All auxiliary cables must be double insulated twisted cables with cross sectional area of 0.5mm² ~ 1.5mm² for maximum connection length between 25m and 50m.

1.7.4 Generator Input Dry Contact

J5 is the status interface for generator connection. Connect J5-2 with J5-1, it indicates that the generator has been connected with the system. The interface diagram is shown in *fig.1-7*, and interface description is shown in *table.1-5*.

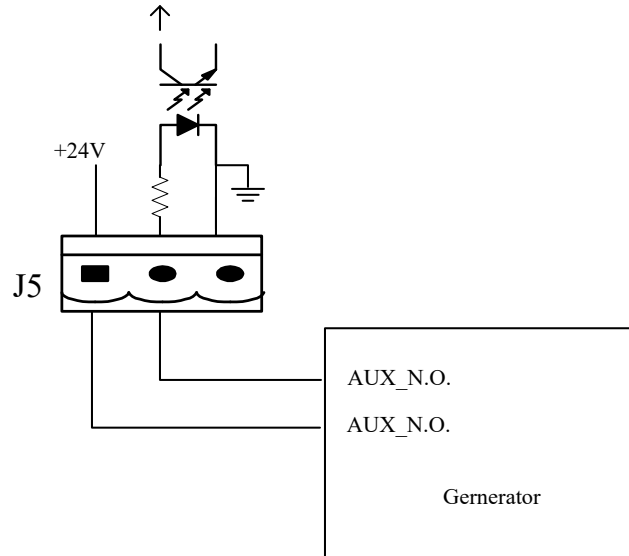

Fig.1- 7: Connection of Generator

Table.1- 6: Description of Status Interface and Connection of Generator

| Position | Name | Purpose |
|----------|------|--------------------------------|
| J5.1 | +24V | Internal +24V power supply |
| J5.2 | GEN | Connection status of generator |
| J5.3 | GND | Power ground |



All auxiliary cables must be double insulated twisted cables with cross sectional area of 0.5mm² ~ 1.5mm² for maximum connection length between 25m and 50m.

1.7.5 BCB Input Port

J6 and J7 are the ports of BCB. The diagram is shown in *fig.1-8*, and description is shown in *table.1-6*.

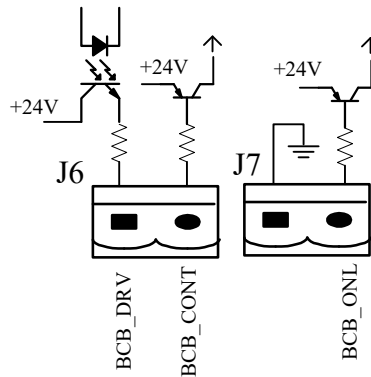



Fig.1- 8: BCB Interface

Table.1- 7: Description of BCB Interface

| Position | Name | Description |
|----------|----------|--|
| J6.1 | BCB_DRV | BCB actuating signal, provide the actuating signal of +24V, 20mA |
| J6.2 | BCB_CONT | BCB contact status, connect with the normally open signal of BCB |
| J7.1 | GND | Common connection |
| J7.2 | BCB_ONL | BCB on-line-input (normally open), BCB is on-line when the signal is connecting with common connection |



All auxiliary cables must be double insulated twisted cables with cross sectional area of 0.5mm² ~ 1.5mm² for maximum connection length between 25m and 50m.

1.7.6 Battery Warning Output Dry Contact Interface

J8 is the output dry contact interface, which outputs the battery warnings of low or excessive voltage, when the battery voltage is lower than set value, an auxiliary dry contact signal will be provided via the isolation of a relay. The interface diagram is shown in *fig.1-9*, and description is shown in *table.1-7*.

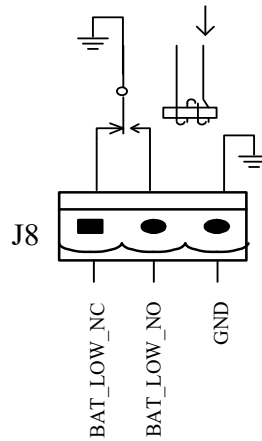

Fig.1- 9: Battery Low Warning Dry Contact

Table.1- 8: Battery warning dry contact interface description

| Position | Name | description |
|----------|------------|---|
| J8.1 | BAT_LOW_NC | Battery warning relay (normally closed) will be open during warning |
| J8.2 | BAT_LOW_NO | Battery warning relay (normally open) will be closed during warning |
| J8.3 | GND | Common connection |

1.7.7 Integrated Warning Output Dry Contact Interface

J9 is the integrated warning output dry contact interface, when one or more than one present warning is triggered, the system will send an integrated warning information, and provide an auxiliary dry contact signal via the isolation of a relay. The interface diagram is shown in *fig.1-10*, and description is shown in *table.1-8*.

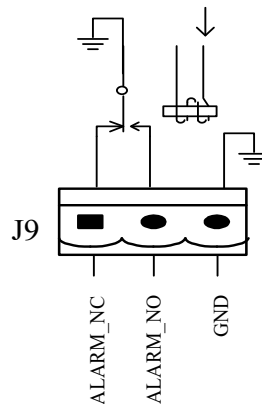



Fig.1- 10: Integrated warning dry contact

Table.1- 9: Integrated warning dry contact interface description

| Position | Name | Purpose |
|--|----------|--|
| J9.1 | ALARM_NC | Integrated warning relay (normally closed) will be open during warning |
| J9.2 | ALARM_NO | Integrated warning relay (normally open) will be closed during warning |
| J9.3 | GND | Common connection |
|  | | |
| All auxiliary cables must be double insulated twisted cables with cross sectional area of 0.5mm ² ~ 1.5mm ² for maximum connection length between 25m and 50m. | | |

1.7.8 Mains Failure Warning Output Dry Contact Interface

J10 is the output dry contact interface for utility failure warning, when the utility fails, the system will send a utility failure warning information, and provide an auxiliary dry contact signal via the isolation of a relay. The interface diagram is shown in *fig.1-11*, and description is shown in *table.1-9*.

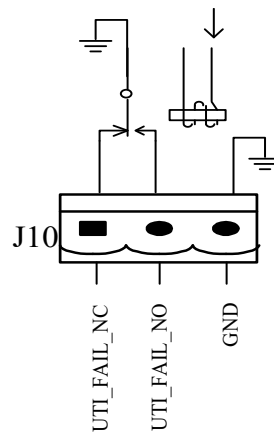



Fig.1- 11: Utility Failure Warning Dry Contact

Table.1- 10: Description of Mains failure warning dry contact

| Position | Name | Purpose |
|--|-------------|---|
| J10.1 | UTI_FAIL_NC | Mains failure warning relay(normally closed) will be open during warning |
| J10.2 | UTI_FAIL_NO | Mains failure warning relay (normally open) will be closed during warning |
| J10.3 | GND | Common connection |
|  | | |
| All auxiliary cables must be double insulated twisted cables with cross sectional area of 0.5mm ² ~ 1.5mm ² for maximum connection length between 25m and 50m. | | |

Chapter 2 Battery Installation and Maintenance

2.1 General Recommendations

Take special care when operating the batteries of the Modular UPS system. When all the battery cells are connected, the battery voltage can exceed 400Vdc, which is potentially lethal.



The precautions for battery installation, use and maintenance are to be provided by the batteries manufacturers. The precautions in this section include the key issues that must be considered during the installation design, which may be adjusted according to the specific local situations.



Battery Room Design

- The battery shall be installed and stored in a clean, cool and dry environment.
- Do not install the battery in a sealed battery chamber or sealed room. The battery room ventilation shall at least meet the requirement of EN50272-2001. Otherwise, battery bulging, fire and even human injury may be caused.
- The battery shall be installed far away from the heating source (e.g. transformer). Do not use or store the battery in the place near the heating source or burn the battery or place it into fire. Otherwise, battery leakage, bulging, fire or explosion may be caused.
- Batteries shall be placed in such a manner that two bare live parts with the potential difference of more than 150V shall not be contacted at the same time. If it is unavoidable, insulated terminal cover and insulated cables shall be used for connection.
- If external batteries are to be used, the battery circuit breakers (or fuses) must be mounted as close as possible to the batteries, and the connecting cables should be as short as possible.



Battery Handling

When connecting the battery, follow the precautions for high-voltage operation

- Before accepting and using the battery, check the appearance the battery. If the package is damaged, or the battery terminal is dirty, corroded or rusted or the shell is broken, deformed or has leakage, replace it with new product. Otherwise, battery capacity reduction, electric leakage or fire may be caused.
 - Before operating the battery, remove the finger ring, watch, necklace, bracelet and any other metal jewelry
 - Wear rubber gloves.
 - Eye protection should be worn to prevent injury from accidental electrical arcs.
 - Only use tools (e.g. wrench) with insulated handles.
- The batteries are very heavy. Please handle and lift the battery with proper method to prevent any human injury or damage to the battery terminal.
- Do not decompose, modify or damage the battery. Otherwise, battery short circuit, leakage or even human injury may be caused.
- The battery contains sulfuric acid. In normal operation, all the sulfuric acid is attached to the separation board and plate in the battery. However, when the battery case is broken, the acid will leak from the battery. Therefore, be sure to wear a pair of protective glasses, rubber gloves and skirt when operating the battery. Otherwise, you may become blind if acid enters your eyes and your skin may be damaged by the acid.
- At the end of battery life, the battery may have internal short circuit, drain of electrolytic and erosion of positive/negative plates. If this condition continues, the battery may have temperature out of control, swell or leak. Be sure to replace the battery before these phenomena happen.
- If a battery leaks electrolyte, or is otherwise physically damaged, it must be replaced, stored in a container resistant to sulfuric acid and disposed of in accordance with local regulations.
- If electrolyte comes into contact with the skin, the affected area should be washed immediately with water.

2.2 Battery Typologies

According to the requested configuration UPS may need internal and/or external batteries Modular UPS can utilize two different battery typologies:

- **Modular:** consisting of a number of battery boxes each containing 10 batteries that cannot be accessed w/o removing a protective cover, installed in the UPS and / or in a dedicated Modular Battery Cabinet (MBC) that allows to extend the runtime as long as the systems or it's requirements grown adding additional battery modules on-the-fly by means of touch free blind mate connectors.
- **Traditional:** consisting of one or more strings of battery blocks installed on shelves in a locked cabinet or dedicated battery room



The battery modules, regardless if they are mounted internally to the UPS or in the MBC, make uses of strings of 40 batteries.
 The Traditional external battery cabinet can make use of each even number of battery per string between 36 and 44.
 The default factory setting, if the unit is ordered w/o internal battery is 40.
 The cabinet is only for valve regulated maintenance-free lead-acid battery.
CAUTION: The lead acid battery may cause chemistry hazard

2.2.1 Modular Battery Cabinet



- When handling the battery modules please refer to the label on it on how to operate.
 - Please use insulated glove to move battery modules.
 - Do not to OPEN the battery boxes.
 - Voltage between points 1 and 2 (*fig. 2-1*) may exceed 150V DC, so they must not be touched and the cover shall be kept on when not installed
- CAUTION:** The lead acid battery may cause chemistry hazard

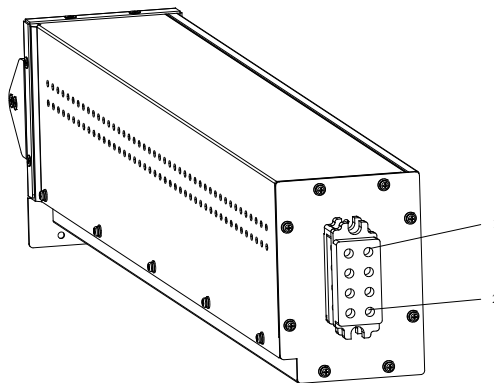

Fig.2- 1: Battery Box

Battery boxes should be stored in a cool place with the protective cover on. Hot and humid place will cause damage to Battery boxes.

2.2.2 Traditional Battery Installation

Only the qualified engineers are allowed to install and maintain mounted in a traditional battery cabinet or shelf. To ensure safety, install the external battery in a locked cabinet or dedicated battery room accessible just to service qualified personnel.

Please note that number of cells set via software must be consistent with the actual number of cells.

A minimum space of 10mm must be reserved on all vertical sides of the battery block to permit free air movement around the cells.

A certain clearance should be reserved between the top of the cells and the underside of the shelf above as this is necessary for monitoring and servicing the cells.

When installing the batteries always work from the bottom shelf upwards to prevent raising the center of gravity.

Install the batteries reliably and avoid vibration and mechanical bumping.

The bending radius of cable should be more than 10D, where "D" is the outer diameter of cable.

When connecting the cable, do not cross the battery cables and do not bind the battery cables together. The battery connection must be firm and reliable. After the connection, all the connections between the wiring terminals and the batteries must be corrected to meet the torque requirement provided in the specifications and user manuals of the battery manufacturers.

Each battery terminal should be insulated after its connection has been made.

Check if the battery is unexpectedly grounded. If the battery is unexpectedly grounded, remove the earth power supply. Contacting any part of the grounded earth may be subject to electric shock.

Measure the battery voltage, and carry out battery voltage calibration after the UPS is started.

Diagram of batteries connection is shown as below:

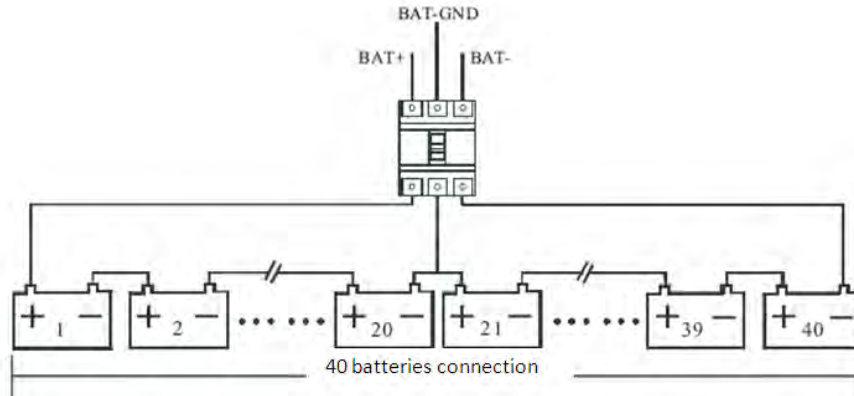

Fig.2- 2: Diagram of Batteries Connection



Warning: Battery connections

When using a traditional battery solution, always comply with the following precautions:

- Disconnect the charging power before connecting or disconnecting the cable of the battery terminals.
- Do not connect the cables between the UPS battery terminals and the batteries before getting the approval from the commissioning engineer.
- When connecting the cables between the battery terminals and the circuit breaker, always connect the circuit breaker end of the cable first.
- Be sure to connect the positive/negative terminals of the batteries to those of the circuit breakers and those of the circuit breakers to those of the UPS respectively with reference to the markings of positive/negative terminals. Reverse connection of battery polarities will result in explosion, fire accident, the damage of batteries and UPS, and human injury.
- The battery connecting terminal shall not subject to any external force, such as the pulling force or twisting force of the cable. Otherwise, the internal connection of the battery may be damaged, and in severe case, the battery may catch fire.
- Do not connect power until the total voltage of the battery string is verified correct through measurement.
- Do not connect any conductor between the positive and negative terminals of the battery.
- Do not close the battery circuit breakers before getting the approval from the commissioning engineer.

2.2.3 Modular Battery Pack Installation

- Unpack battery package and take out battery pack.
- Check if battery cabinet is ok.
- Check if battery voltage between 1 and 2 (fig.2-1) is over 125V and the polarity is correct.
- Insert battery pack in UPS one by one smoothly, make sure that install one string (one layer) and then next string.
- Tighten the screws.

2.3 Modular Battery Maintenance

For the battery maintenance and precautions, please refer to IEEE-Std-1188-2005 and the relevant manuals provided by the battery manufacturers.



Maintenance Note

- Check to ensure that all the safety devices are in place and function normally. Check if the battery management parameter setting is normal particularly.
- Measure and record the air temperature in the battery room.
- Check if the battery terminals are damaged or have the symptom of heating, and if the shell or cover is damaged.
- Please fasten every bolt on the terminal according to the fastening torque specified in the table below.
- After 1-2 months of service, recheck to make sure that each screw has been fastened according to the specified torque. Otherwise there is risk of fire.
- **CAUTION:** Use the battery with the same capacity and type, if battery is replaced by an incorrect type, it can cause explosion.
- **CAUTION:** Dispose of used battery according to the local instructions

2.3.1 Modular Battery Cabinet Maintenance

Pull out battery pack:

1. If there are N strings of batteries, please set the charger power as $(N-1) \times I\% / N$ or lower on LCD, I%—current charger power.
2. Check if the time from latest discharging is over 60 minutes, if not, please wait unit 60 minutes.
3. Check if the battery voltage is over 520V and charger current is under 1.5A, if not, please wait.
4. Loose the screws and pull out battery pack slowly one by one
5. Lay aside the battery pack at safe area

| |
|---|
|  |
| Warning |
| <ul style="list-style-type: none"> ● Battery voltage between 1 and 2(fig.2-1) is over 130V ● Battery pack is over 25kg, it needs two people to carry together |

Replace a new battery pack:

1. Make sure that battery type and capacity are same as old one.
2. New battery pack is forbidden to be inserted in UPS in two hours from latest discharging.
3. Make sure that battery pack voltage is over 125Vdc and the polarity is correct.
4. Insert the new battery pack in UPS and tighten it with screws.

2.4 Modular Battery Selection

Table.2- 1: Internal Battery Selection

| Power(KVA) | Minimum Battery string | 80 | 4 | 150 | 7 |
|------------|------------------------|-----|---|-----|----|
| 20 | 1 | 90 | 5 | 160 | 8 |
| 30 | 2 | 100 | 5 | 170 | 8 |
| 40 | 2 | 110 | 6 | 180 | 9 |
| 50 | 3 | 120 | 6 | 190 | 9 |
| 60 | 3 | 130 | 7 | 200 | 10 |
| 70 | 4 | 140 | 7 | | |

Chapter 3 Installation of UPS Rack System and Parallel System

3.1 Overview

The single or parallel system should be installed according to the installation procedures of the UPS rack module system and the requirements in this Chapter.

For single UPS rack module installation the EPO button on the front panel of the UPS rack controls the emergency stop of UPS modules and bypass static switch and also supports remote emergency power off function that can be used to shut down the UPS rack module remotely.

| |
|---|
|  |
| <ol style="list-style-type: none"> 1. The remote EPO switch must provide normally open or normally closed dry contact signals. 2. The open circuit voltage is 24Vdc, and the current is less than 20mA. 3. Normally closed EPO-J4 terminals: Pin 1 and pin 2 have been connected in factory and located on the dry contact board GJ. |

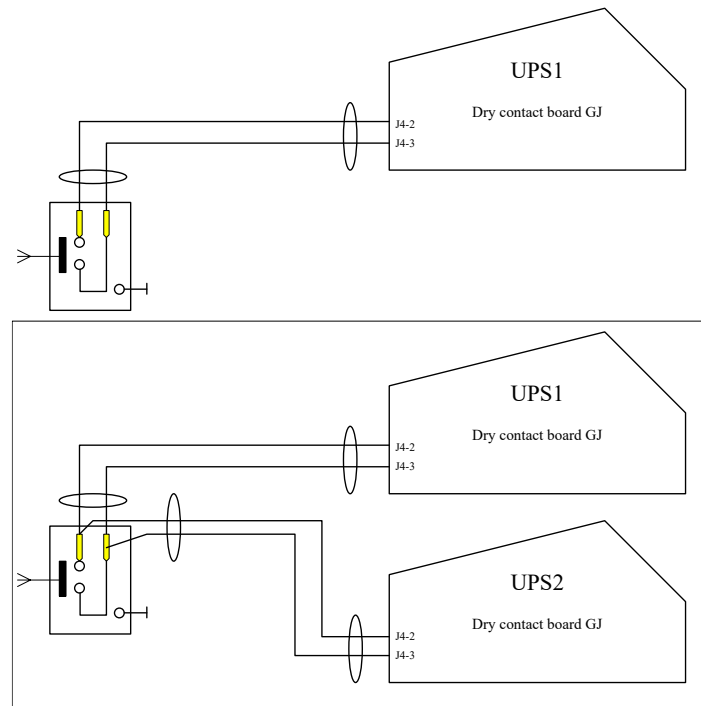

Fig.3- 1: Circuit diagram of EPO

3.2 UPS Rack Modules in Parallel System

The basic installation procedures of parallel system are the same with those of the UPS rack module system. In this section, only the installation procedures related to the parallel system are introduced.

3.2.1 Installation of Cabinet

To make the maintenance and system test easier, an external maintenance bypass is recommended in the installation.

3.2.2 External Protective Devices

Refer to *Chapter 1 Installation*

3.2.3 Power Cables

The power cable connection of the parallel rack module system is similar to that of the single UPS rack module system. If the bypass input and rectifier input share the same neutral terminal and if an RCD protective device is installed at the input, then the RCD device must be installed before the input cables are connected to the neutral terminal. Refer to Chapter 1 Installation

Note: The length and specification of the power cables of each UPS module should be the same, including the bypass input cables and UPS output cables, so that the load sharing effect can be achieved in bypass mode.

3.2.4 Parallel Signal Board

Installation of parallel signal board

The parallel signal board BJ is installed at the rear of the static switch power module. Refer to *fig.3-2*,

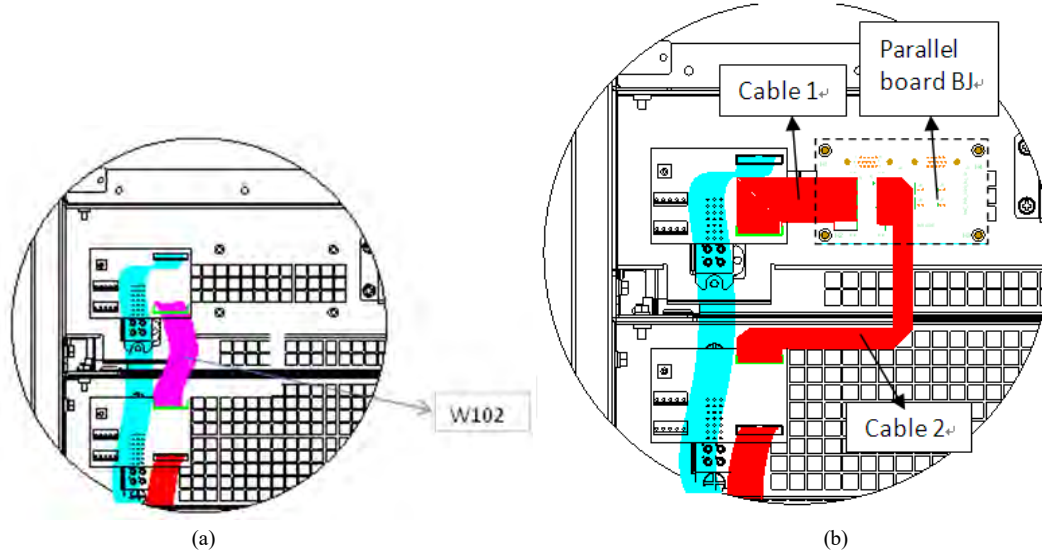

Fig.3- 2: Installation of Parallel Signal Board BJ

- Remove cable W102 as *fig.3-2(a)*
- Install parallel signal board BJ as *fig.3-2(b)*
- Connect cable 1 and cable 2 as *fig.3-2(b)*

3.2.5 Control Cables

Parallel control cable

The parallel control cables are designed to be shielded and double insulated, and are connected between the UPS rack modules to form a loop as shown below. The parallel signal board BJ is installed at the rear of the static switch power module. This close loop connection ensures the reliability of the parallel system control. Refer to *fig. 3-3*

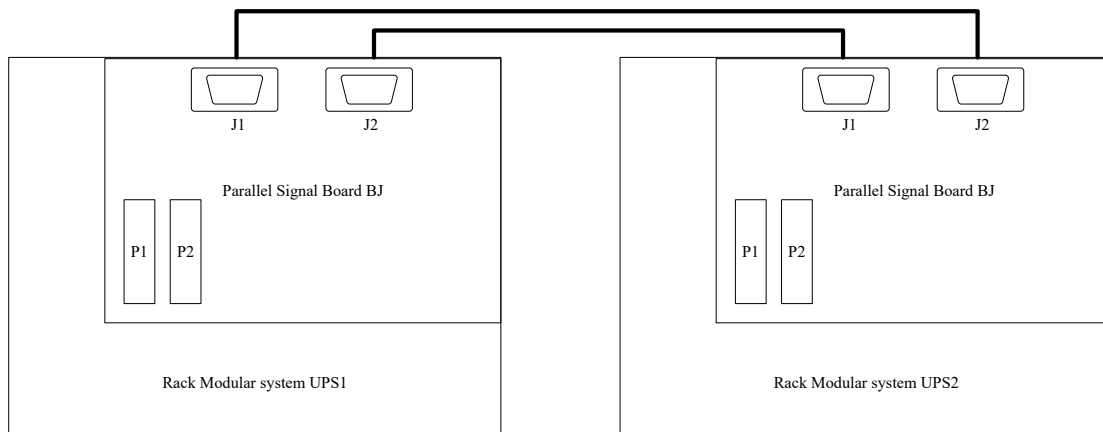

Fig.3- 3: Connection of Parallel Control Cables of "1+N" System

Chapter 4 Installation Drawing

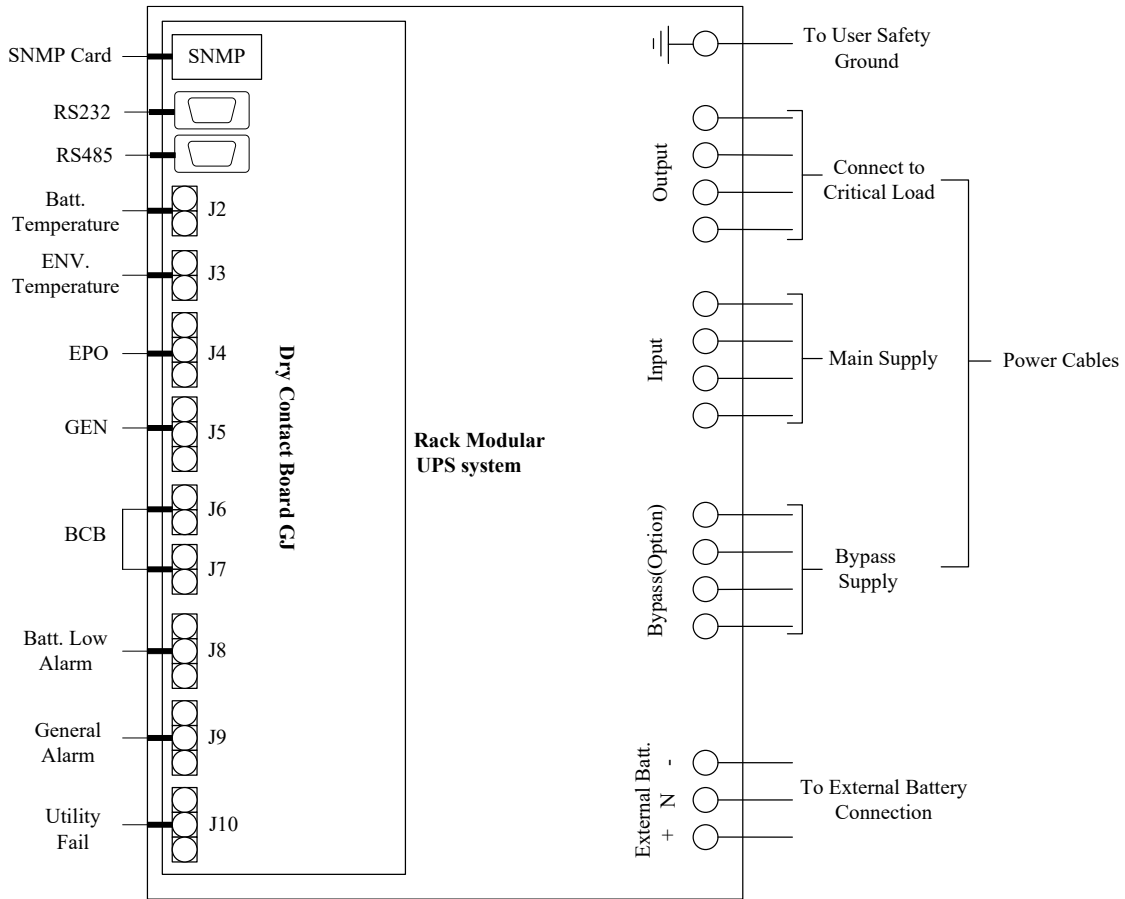

Fig.4- 1: Wiring Diagram

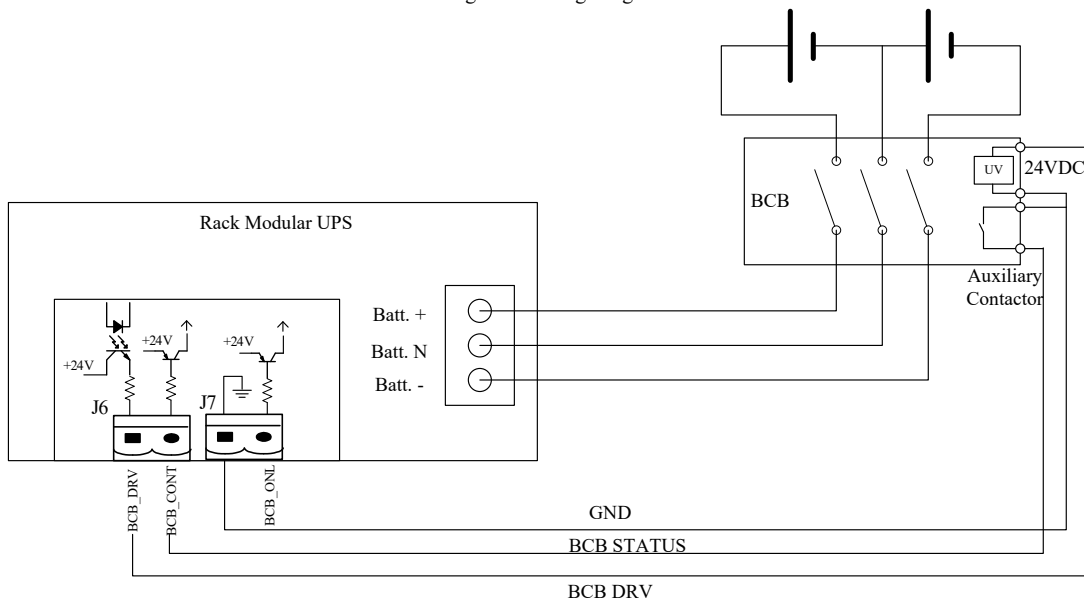

Fig.4- 2: External Battery Connection

- External BCB interface:
 BCB DRV: J6-1 BCB drive signal
 BCB STATUS: J6-2 BCB contactor status, normally opened. Shorted to GND when activated
 GND: J7-1 ground

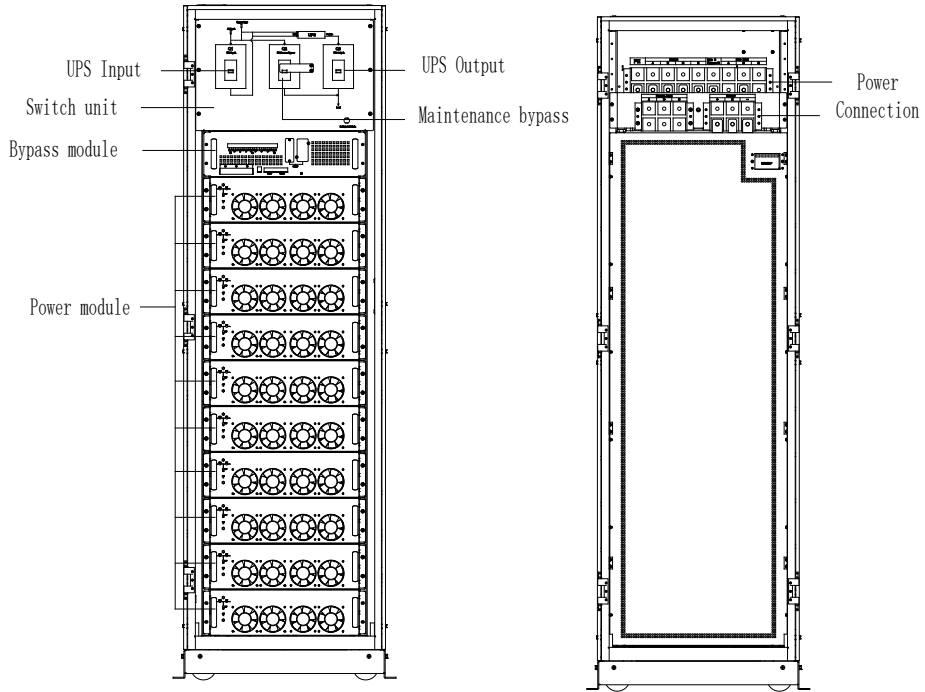

Fig.4- 3: 60KVA UPS Built-in Battery Module System, Front and Rear View without Doors

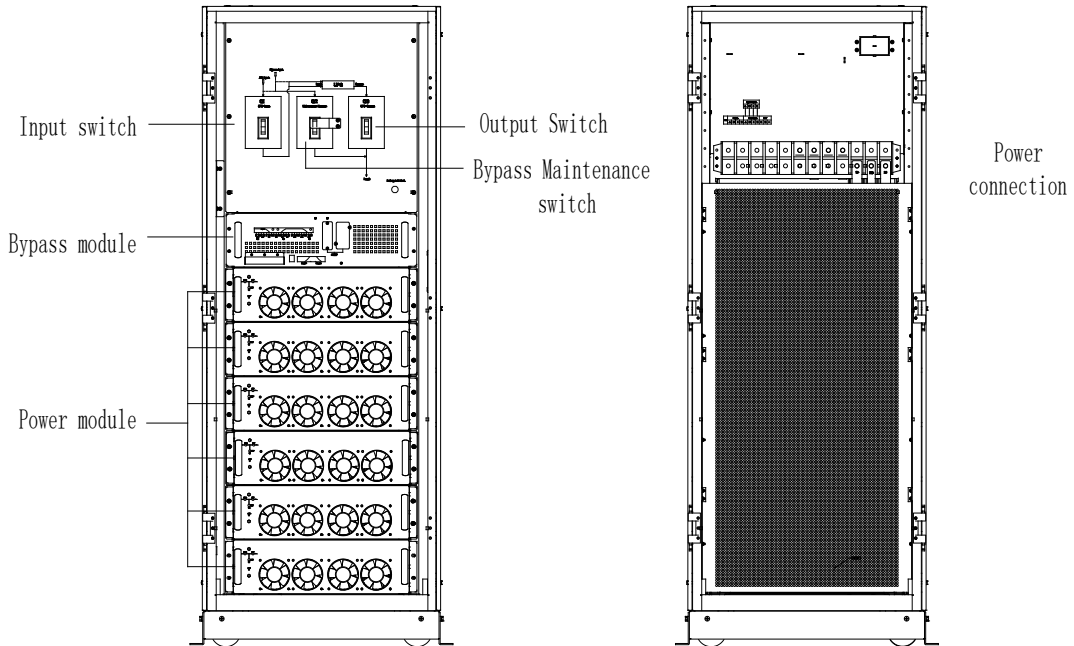

Fig.4- 4: 200KVA UPS Module System, Front View and Rear View without Door

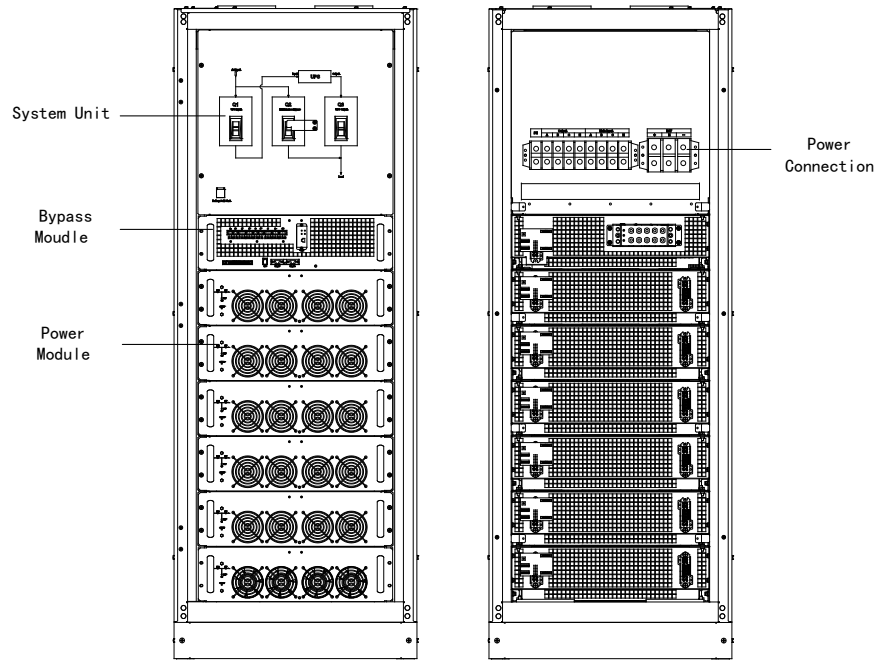

Fig.4- 5: 120KVA UPS Module System, Front View and Rear View without Door

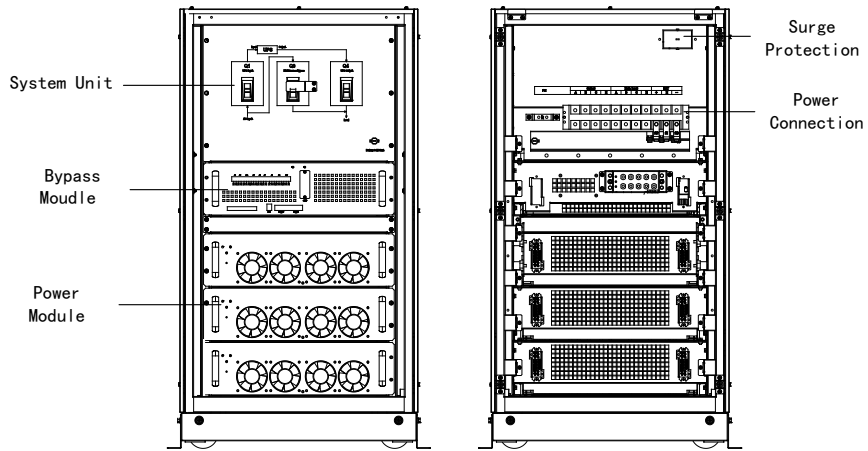

Fig.4- 6: 60KVA UPS Module System, Front View and Rear View without Door

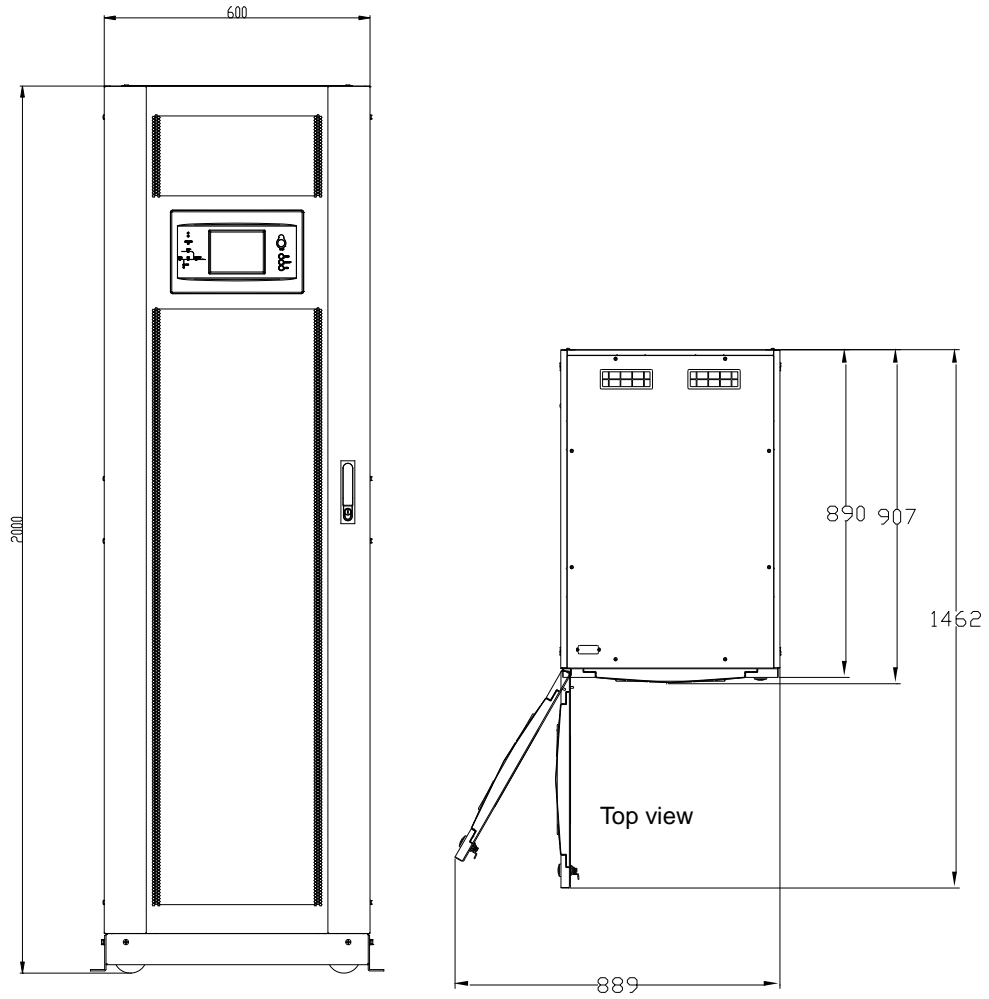

Fig.4- 7: 200KVA UPS External Dimensions 顶视图

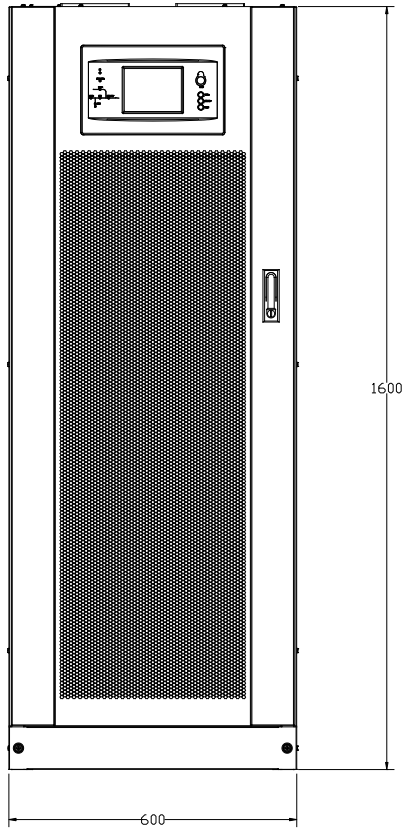

Fig.4- 8: 120KVA UPS External Dimensions

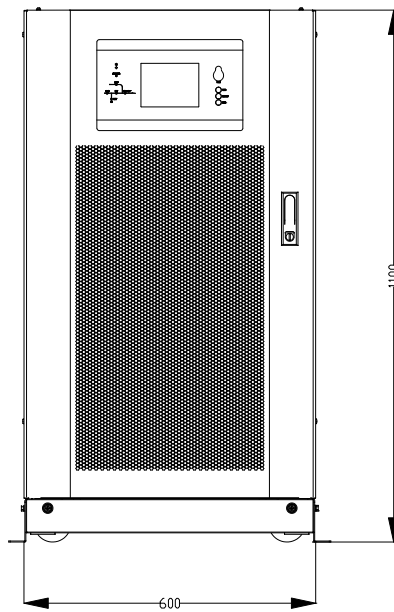

Fig.4- 9: 60KVA UPS External Dimensions

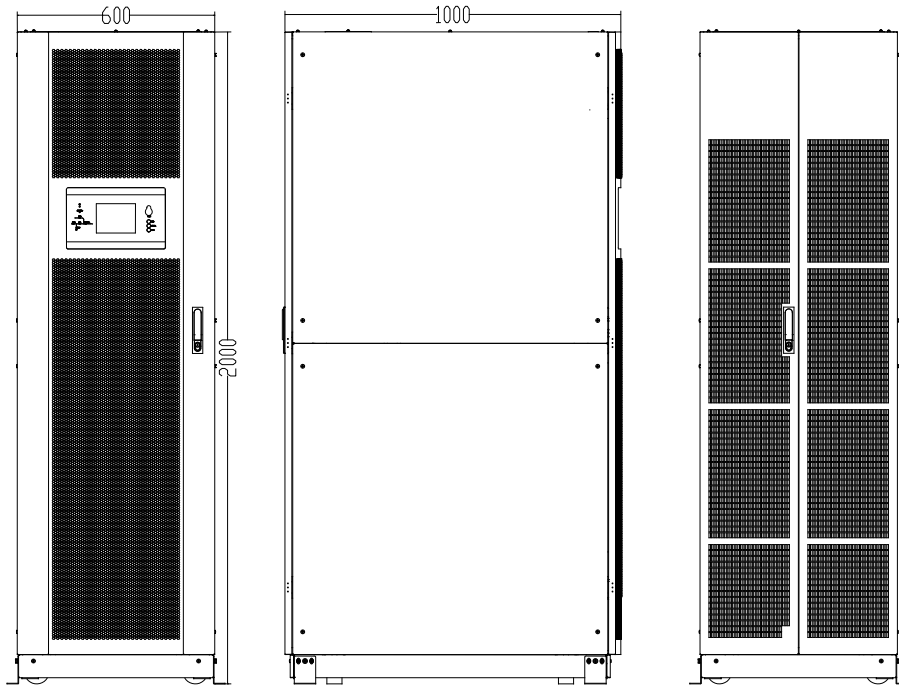
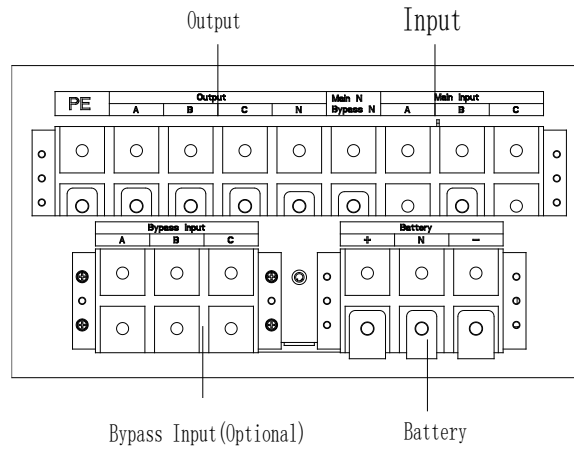
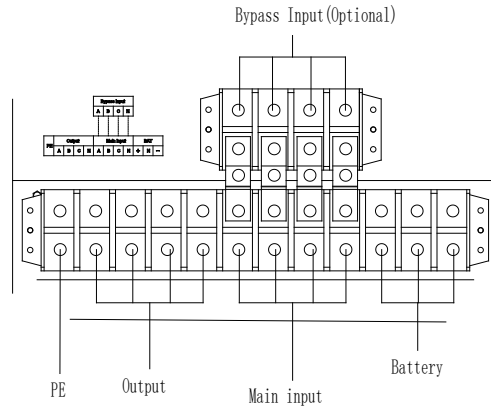

Fig.4- 10: 60KVA Built-in Battery UPS Module System External Dimensions



(a) 200KVA UPS power connection



(b) 120KVA UPS power connection

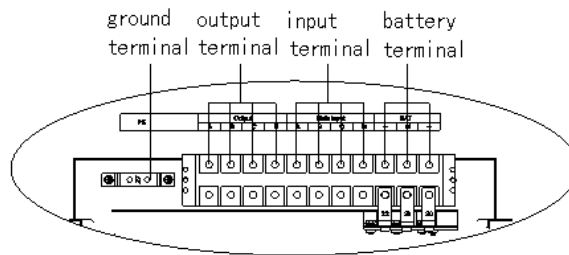

(c) 60KVA UPS power connection

Fig.4- 11: Power Connection of Module System UPS

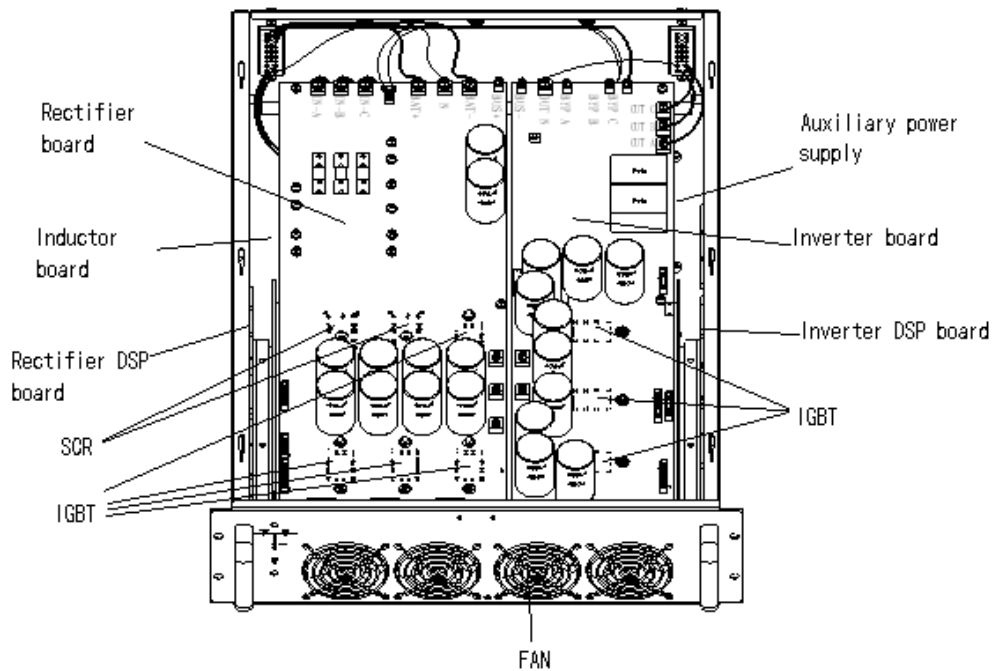

Fig.4- 12: Power Module

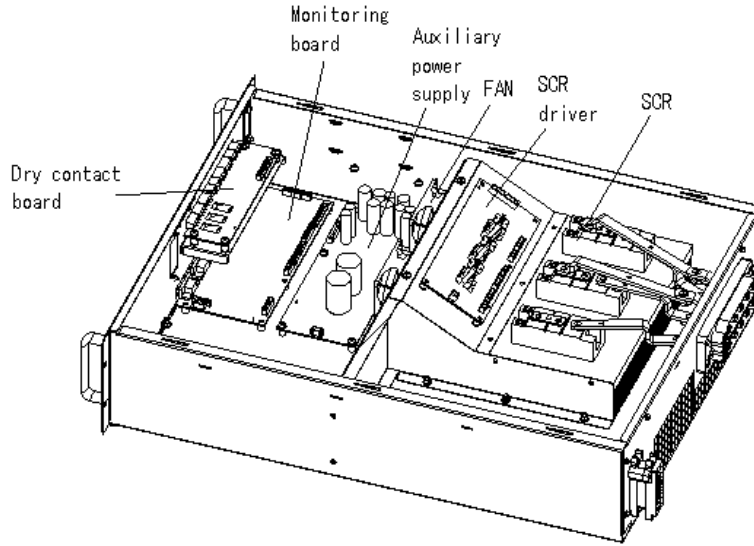

Fig.4- 13: Static Bypass Module

Notes for installing modules:

1. When installing the modules, install the modules from bottom to top. When removing the modules, remove the modules from top to bottom. The purpose is to maintain the stable center of gravity.
2. After inserting the module, tighten all the screws.
3. When removing the modules, turn off modules first, remove the screws and then remove the modules.
4. Wait for 5 minutes before inserting the removed modules.

4.1 Internal Battery Module

4.1.1 Appearance of Internal Battery Module

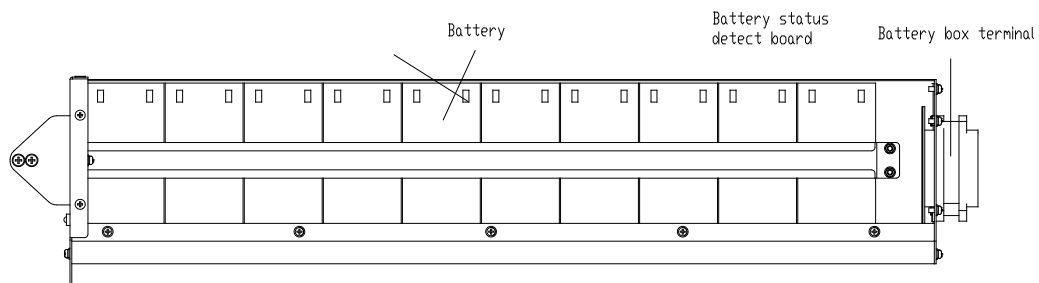

Fig.4- 14: Battery Module

According to the selected configuration, the built-in battery modular UPS can house from none to 4 strings of battery in parallel.

Each Modular Battery Cabinet can house additional 8 strings of battery.

Each string is made of 4 battery modules. Each battery module contains ten 9AH/12V batteries and each battery tray has one 50A DC current limiting fuse. The maximum discharging current of each layer of battery is 45A. Over charging current will break the fused and the LED on front of battery module will display the fault.

| |
|--|
| |
| <p>When using modular battery it is important to install at least 2 battery module per each power module installed. Not doing that will result in the fused broken before the battery reaches the EOD.</p> |
| |

Battery housed in the external Modular Battery Cabinet must be of the same kind of the internal ones.

Chapter 5 Operations



Warning: Hazardous mains voltage and/or battery voltage present(s) behind the protective cover

The components that can only be accessed by opening the protective cover with tools cannot be operated by user. Only qualified service personnel are authorized to remove such covers.

5.1 Introduction

The Modular UPS rack system provides the critical load (such as communication and data processing equipment) with high quality uninterruptible AC power. The power from the UPS is free from voltage and frequency variations and disturbances (interruption and spike) experienced at the Mains AC input supply.

This is achieved through high frequency double conversion power pulse width modulation (PWM) associated with fully digital signal processing control (DSP), which features high reliability and convenience for use.

As shown in *fig.5-1*, the AC input mains source is supplied at UPS input and converted into a DC source. This DC source feeds the Inverter that converts the DC source into a clean and input independent AC source. The battery powers the load through the inverter in case of an AC input mains power failure. The utility source can also power the load through the static bypass.

When the UPS needs maintenance or repair, the load can be transferred to maintenance bypass without interruption and the power module and bypass module can be removed for maintenance.

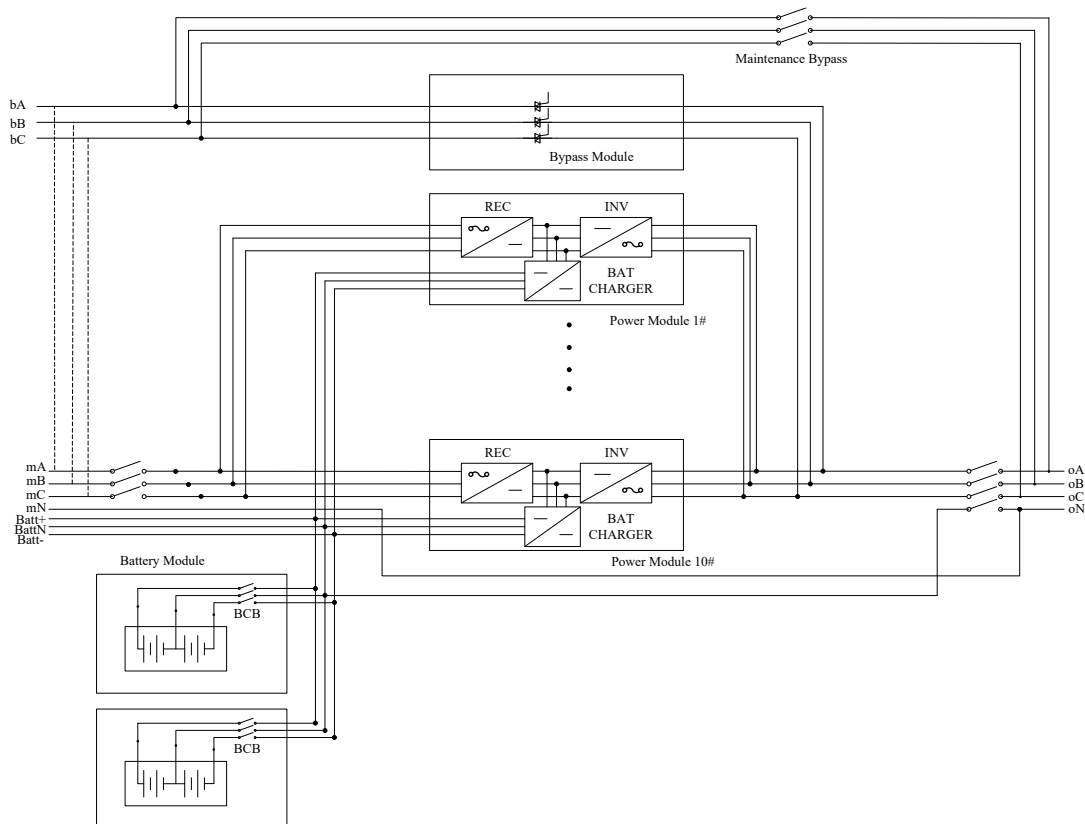

Fig.5- 1: Single Unit Block Diagram

5.1.1 Split-Bypass Input

Fig. 5-1 illustrates the Modular UPS in what is known as the split-bypass configuration (that is, the bypass uses a separate AC source). In this configuration, the static bypass and maintenance bypass share the same independent bypass power supply and connect to the

power supply through a separate switch. Where a separate power source is not available, the bypass and rectifier input supply connections are linked.



Split-Bypass Input function is optional.

5.1.2 Static Transfer Switch

The circuit blocks labeled Static Switch in *fig.5-1* contain electronically controlled switching circuits that enable the critical load to be connected to either the inverter output or to a bypass power source via the static bypass line. During normal system operation the load is connected to the inverter; but in the event of a UPS overload or inverter failure, the load is automatically transferred to the static bypass line. To provide a clean (no-break) load transfer between the inverter output and static bypass line, the inverter output and bypass supply must be fully synchronized during normal operating conditions. This is achieved through the inverter control electronics, which makes the inverter frequency track that of the static bypass supply, provided that the bypass remains within an acceptable frequency window.

A manually controlled maintenance bypass supply is incorporated into the UPS design. It enables the critical load to be powered from the utility (bypass) supply while the UPS is shut down for routine maintenance.



When the UPS is operating in bypass mode or on maintenance bypass, the connected equipment is not protected from power failures or surges and sags.

5.2 1+1 Parallel System

Several “single unit” UPS modules may constitute a “1+1” system, where up to two single units operate together for the purpose of providing additional power or reliability or both. The load is equally shared between any paralleled UPSs.

In addition, two UPS modules or 1+1 groups may be configured as “distributed redundant” systems. Each UPS module or system has independent outputs that nevertheless are synchronized through a Load Bus Synchronizer (LBS) so that critical loads can be seamlessly transferred from one system to another. See *5.3 Operating Mode* for more information.

5.2.1 Features of Parallel System

1. The hardware and firmware of single module UPS units are completely compatible with the requirements of a parallel system. Parallel configuration can be achieved merely through settings in configuration software. The parameters settings for the modules in parallel system shall be consistent.
2. Parallel control cables are connected in a ring, providing both performance and redundancy. Dual-bus control cables are connected between any two UPS modules of each bus. The intelligent paralleling logic provides the user with maximum flexibility. For example, shutting down or starting up UPS modules in a parallel system can be done in any sequence. Transfers between Normal and Bypass modes of operation are synchronized and self-recovering e.g. following overloads and their clearance.
3. The total load of the parallel system can be queried from each module's LCD.

5.2.2 Parallel Requirements of UPS Modules

A group of paralleled modules behave as if it were one large UPS with the advantage of presenting higher reliability. In order to assure that all modules are equally utilized and to comply with relevant wiring rules, the following requirements apply:

1. All UPS modules shall be of the same rating and must be connected to the same bypass source.
2. The bypass and the main input sources must be referenced to the same neutral potential.
3. Any RCD (Residual Current detecting device), if installed, must be of an appropriate setting and located upstream of the common neutral bonding point. Alternatively, the device must monitor the protective earth currents of the system. Refer to the High Leakage Current Warning in the first part of this manual.
4. The outputs of all UPS modules must be connected to a common output bus.
5. It is strongly recommended that each paralleled UPS install at least a redundant power module



Optional isolation transformers are available for applications where sources do not share the same neutral reference or where the neutral is not available.

5.3 Operating Mode

The Modular UPS is an on-line, double-conversion, reverse-transfer UPS that permits operation in these modes:

- Normal mode
- Battery Mode
- Auto-restart mode
- Bypass mode
- Cold start mode
- Maintenance mode (manual bypass)
- Parallel redundancy mode
- Eco Mode

5.3.1 Normal Mode

The UPS inverter power modules continuously supplies the critical AC load. The rectifier/charger derives power from the AC mains input source and supplies DC power to the inverter while simultaneously FLOAT or BOOST charging its associated backup battery.

5.3.2 Battery Mode

Upon failure of the AC mains input power; the inverter power modules, which obtains power from the battery, supplies the critical AC load. There is no interruption in power to the critical load upon failure. After restoration of the AC mains input power, the “Normal Mode” operation will continue automatically without the necessity of user intervention.

5.3.3 Auto-Restart Mode

The battery may become exhausted following an extended AC mains failure. The inverter shuts down when the battery reaches the End of Discharge voltage (EOD). The UPS may be programmed to “Auto Recovery after EOD” after a delay time if the AC mains recovers. This mode and any delay time are programmed by the commissioning engineer.

5.3.4 Bypass Mode

If the inverter overload capacity is exceeded under normal mode, or if the inverter becomes unavailable for any reason, the static transfer switch will perform a transfer of the load from the inverter to the bypass source, with no interruption in power to the critical AC load. Should the inverter be asynchronous with the bypass, the static switch will perform a transfer of the load from the inverter to the bypass with power interruption to the load. This is to avoid large cross currents due to the paralleling of unsynchronized AC sources. This interruption is programmable but typically set to be less than 3/4 of an electrical cycle, e.g., less than 15ms (50Hz) or less than 12.5ms (60Hz).

5.3.5 Cold Start Mode

If there is no utility input and want UPS to start from battery mode, UPS can start up from Cold start mode

5.3.6 Maintenance Mode (Manual Bypass)

A manual bypass switch is available to ensure continuity of supply to the critical load when the UPS becomes unavailable e.g. during a maintenance procedure.

5.3.7 Parallel Redundancy Mode (System Expansion)

For higher capacity or higher reliability or both, the outputs of several UPS modules can be programmed for direct parallel while a built-in parallel controller in each UPS ensures automatic load sharing. A parallel system can be composed of up to two UPS modules.

5.3.8 Eco Mode

To improve system efficiency, UPS rack system works in bypass mode at normal time, and inverter is standby. When utility fails, UPS transfer to battery mode, and inverter power the loads. The efficiency of ECO system can be up to 98%.

NOTE: There is a short interruption time (lower than 10ms) when transfer from ECO mode to battery mode, it must be sure that the time has no effect on loads.

5.4 Battery Management—Set During Commissioning

5.4.1 Normal Function

1. Constant Current Boost Charging

Current can be set up as 1%~20%, default setting is 10%.

2. Constant Voltage Boost Charging

Voltage of boost charging can be set as required by the type of battery.

For Valve Regulated Lead Acid (VRLA) batteries, maximum boost charge voltage should not exceed 2.4V / cell.

3. Float Charge

Voltage of float charging can be set as required by the type of battery.

For VRLA, float charge voltage should be between 2.2V to 2.3V, default setting is 2.25V.

4. Float Charge Temperature Compensation (optional)

A coefficient of temperature compensation can be set as required by the type of battery.

5. End of Discharge (EOD) Protection

If the battery voltage is lower than the EOD, the battery converter will shut down and the battery is isolated to avoid further battery discharge. EOD is adjustable from 1.6V to 1.75V per cell (VRLA).

5.4.2 Advanced Functions (Software Settings Performed by the Commissioning Engineer)

Battery self-test and self-service

At periodic intervals, 25% of the rated capacity of the battery will be discharged automatically, and the actual load must exceed 25% of the rated UPS (kVA) capacity. If the load is less than 25%, auto-discharge cannot be executed. The periodic interval can be set from 720 to 3000 hours.

Conditions: Battery at float charge for at least 5 hours, load equal to 25~100% of rated UPS capacity Trigger—Manually through the command of Battery Maintenance Test in LCD panel or automatically Battery self-test interval.

5.5 Battery Protection (Settings by Commissioning Engineer)

Battery Low Pre-warning

The battery undervoltage pre-warning occurs before the end of discharge. After this pre-warning, the battery should have the capacity for 3 remaining minutes discharging with full load. And the

End of discharge (EOD) protection

If the battery voltage is lower than the EOD, the battery converter will be shut down. EOD is adjustable from 1.6V to 1.75V per cell (VRLA).

Battery Disconnect Devices Alarm

The alarm occurs when the battery disconnect device disconnects. The external battery connects to the UPS through the external battery circuit breaker. The circuit breaker is manually closed and tripped by the UPS control circuit.

Chapter 6 Operating Instructions



Warning-Hazardous mains voltage and/or battery voltage present(s) behind the protective cover

The components that can only be accessed by opening the protective cover with tools cannot be operated by user. Only qualified service personnel are authorized to remove such covers.

6.1 Introduction

The Modular UPS operates in the following 3 modes listed in *table.6-1*. This section describes various kinds of operating procedures under each operating mode, including transfer between operating modes, UPS setting and procedures for turning on/off inverter.

Tab.6-1: UPS Operating mode

| Operating mode | Descriptions |
|------------------|--|
| Normal mode | UPS powers the load |
| Bypass mode | The load power supply is provided by the static bypass. This mode can be regarded as a temporary transition mode between the normal mode and maintenance bypass mode, or a temporary abnormal operating status |
| Maintenance mode | UPS Shuts down, the load is connected to the mains via Maintenance bypass. NOTE: in this mode the load is not protected against abnormal mains |

Note:

1. Refer to Chapter 7 Operator Control and Display Panel, for all the user operating keys and LED displays.
2. The audible alarm may annunciate at various points in these procedures.
3. The UPS function can be set via maintenance software. However, the setting and commissioning must be done by maintenance engineers trained.

6.1.1 Power Switches

The UPS rack system has a maintenance bypass breaker, a main input breaker and a output breaker, and all the other transfers are processed automatically by internal control logics.

6.2 UPS Startup

Do not start the UPS until the installation is completed, the system has been commissioned by authorized personnel and the external power isolators are closed.

6.2.1 Start-Up Procedure

This procedure must be followed when turning on the UPS from a fully powered down condition.

The operating procedures are as follows:

1. Open the external power switch. Open the internal power switch. Open the UPS door, connect the power supply cables and ensure the correct phase rotation.



During this procedure the UPS output terminals are live. If any load equipment are connected to the UPS output terminals please check with the load user that it is safe to apply power: If the load is not ready to receive power then ensure that it is safely isolated from the UPS output terminals.

2. **Close the output circuit breaker (Q3). Close the mains input circuit breaker (Q1) and connect the mains power.** The LCD starts up at this time. The Rectifier indicator flashes during the startup of rectifier. The rectifier enters normal operation state, and after about 20s, the rectifier indicator goes steady green. After initialization, the bypass static switch closes. The UPS Mimic LEDs will indicate as following:

| LED | Status |
|---------------------|--------|
| Rectifier indicator | Green |
| Battery indicator | Red |
| Bypass indicator | Green |
| Inverter Indicator | Off |
| Load indicator | Green |
| Status indicator | Green |



The output circuit breaker (Q3) must be closed first, followed by input circuit breaker (Q1), or the rectifier cannot be started.

3. **The inverter starts up automatically.** The inverter indicator flashes during the startup of inverter. After about 1 minute, the inverter is ready, the UPS transfers from bypass to inverter, the bypass indicator turns off, and the inverter and load indicators turn on. The UPS is in normal mode. The UPS Mimic LEDs will indicate as following:

| LED | Status |
|---------------------|--------|
| Rectifier indicator | Green |
| Battery indicator | Red |
| Bypass indicator | Off |
| Inverter Indicator | Green |
| Load indicator | Green |
| Status indicator | Green |

4. Close external battery switch, battery indicator turns off, a few minutes later, the battery will be charged by UPS. The UPS Mimic LEDs will indicate as following:

| LED | Status |
|---------------------|--------|
| Rectifier indicator | Green |
| Battery indicator | Green |
| Bypass indicator | Off |
| Inverter Indicator | Green |
| Load indicator | Green |
| Status indicator | Green |

6.2.2 Procedures for Switching Between Operation Modes

Switch from normal mode to bypass mode



Press “Tran byp” menu in menu to switch to bypass mode.



In bypass mode, the load is directly fed by the mains power instead of the pure AC power from the inverter.

Switch from bypass mode to normal mode

Press “Esc byp” menu in bypass mode. After the inverter enters normal operation, the UPS transfers to normal mode.

Battery Start

- Verify that the battery is properly connected.
- Press the cold start-up button (see as fig.6-1) under the rectifier input circuit breaker for 1 seconds
- At this point, the LCD displays the start screen, press cold start-up button again. And the battery indicator flashes green. It stops flashing and becomes solid green about 10 seconds after the rectifiers enter normal operation.
- The inverter starts up automatically, the green inverter indicator flashes. The UPS works in battery mode after 60 seconds.

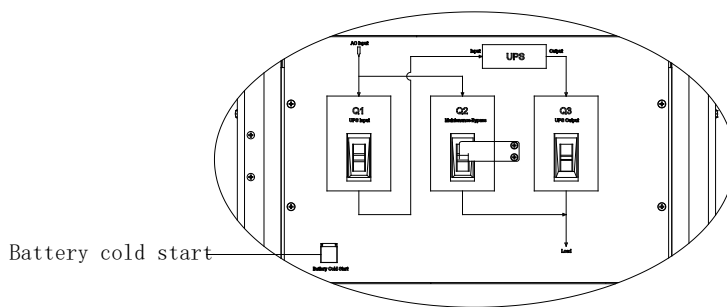

Fig.6- 1: Location of Battery Cold Start Button

6.3 Procedure for Switching the UPS between Maintenance Bypass and Normal Mode

6.3.1 Procedure for Switching from Normal Mode to Maintenance Bypass Mode

This procedure can transfer the load from the UPS inverter output to the maintenance bypass supply, but the precondition is that the UPS is in normal mode before the transfer.



Before making this operation, read messages on display to be sure that bypass supply is regular and the inverter is synchronous with it, so as not to risk a short interruption in powering the load.

1. Press the “Tran Byp” menu in  on the right side of the LCD. The UPS Mimic indicator Inverter will green flash and also the Status Indicator will turn red and will be accompanied by an audible alarm. The load transfers to static bypass, and the inverter standby.



Pressing the Alarm Silence button  cancels the audible alarm but leaves the warning message displayed until the alarm condition is rectified.

2. Open the UPS front door, close the maintenance bypass breaker (Q2) from OFF to ON position. The load power supply is provided by the manual maintenance bypass.
3. Press EPO to make sure the charge current is 0. Open the mains input breaker (Q1) and output breaker (Q3), open the external battery breaker and internal battery breaker (if built-in battery modular UPS)



If you need to maintain the module, wait for 10 minutes to let the DC bus capacitor fully discharge before removing corresponding module.

When the maintenance bypass switch is on position of ON, some part of the UPS circuit still has hazardous voltage. Therefore, only qualified person can maintain the UPS.



When the UPS is in maintenance bypass mode, the load is not protected against abnormal mains supply.

6.3.2 Procedure for Switching from Maintenance Mode to Normal Mode

1. Close output breaker (Q3). Close mains input breaker (Q1). The LCD starts up at this time. The Rectifier indicator flashes during the startup of rectifier. The rectifier enters normal operation state, and after about 20s, the rectifier indicator goes steady

green. After initialization, the bypass static switch closes.

2. Open the manual maintenance breaker (Q2).



Before opening the maintenance breaker (Q2), make sure that static bypass switch is working according power flow displayed on LCD.

3. After about 60s, UPS transfers to inverter. Close external battery breaker and internal battery breaker (for battery built-in cabinet).

6.4 Procedure for Completely Powering Down a UPS

If you need to power down the UPS completely, follow the procedures as:

- Press EPO button on the right side of operation panel
- Open external battery breaker and internal battery breaker
- Open mains input breaker (Q1) and output breaker (Q3)

If you need to isolate the UPS from the AC power supply, you should open the external input power supply isolation first (if the rectifier and bypass use different power supply, you need to open these two input isolation respectively).

6.5 EPO Procedure

The EPO button is designed to switch off the UPS in emergency conditions (e.g., fire, flood, etc.).To achieve this, just press the EPO button, and the system will turn off the rectifier, inverter and stop powering the load immediately (including the inverter and bypass), and the battery stops charging or discharging.

If the input utility is present, the UPS control circuit will remain active; however, the output will be turned off. To completely isolate the UPS, you need to open the mains input breaker and battery breaker.

6.6 Auto Start

Commonly, the UPS rack is start up on static bypass. When the mains power fails, the UPS draws power from the battery system to supply the load until the battery voltage reaches the end of discharge (EOD) voltage, and the UPS will shut down.

The UPS will automatically restart and enable output power:

- After the mains power is restored
- If the Auto Recovery after EOD Enabling feature is enabled

6.7 UPS Reset Procedure

After using EPO to shut down the UPS, operates as following to restore UPS:

- Shutdown UPS completely
- Start UPS as *section 6.2.1*

After the UPS is shut down due to inverter over temperature, or overload, or too many switching times, UPS will reset the fault automatically when fault is cleared.



The rectifier will be turned on automatically when the over temperature fault disappears after the disappearance of over temperature signals.

After pressing the EPO button, if the UPS mains input has been disconnected, the UPS is completely powered down. When the mains input is restored, the EPO condition will be cleared and the UPS system will enable static bypass mode to restore the output.



If the maintenance bypass breaker is put to ON and the UPS has mains input, then the UPS output is energized.

6.8 Operation Instruction for Power Module Maintenance

Only a trained operator can perform the following procedures

Maintenance guidance for power modules

If the system is normal mode and the bypass is normal, the redundant number of power module is at least 1:

1. Enter in function menu (need password 2) and press “FaultClr” to release shutdown power module function.
2. Press “off” button on the front panel of power module to manually power off power module.
3. Loose the screws of the main power module and remove the module after 2 minutes.

If there are no redundant power modules:

1. Enter in function menu (need password 2) and press “Tran byp” to transfer to bypass mode.
2. Loosen the screws of the main power module and remove the module after 2 minutes.



To ensure the safety, be sure to use a multi-meter to measure the DC bus capacitor voltage and ensure the voltage is below 60V before operation.

3. After finishing the maintenance of the power module, insert the main power module (the inserting interval for each module is longer than 10s), the power module will automatically join the system operation, and then tighten the screws at the two sides of the power module.

Maintenance guidance for bypass power module



The bypass power module cannot be maintained in battery mode.

If the system is in normal mode and the bypass is normal:

1. Manually shut down the inverter, and the UPS transfers to bypass. Close the maintenance bypass breaker and the UPS transfer to maintenance bypass mode.
2. Press EPO button to ensure the battery current is 0. Open the battery circuit breaker or disconnect battery terminals.
3. Open mains input breaker and output breaker.
4. Remove the bypass power modules that need maintenance or repair, wait for 5 minutes and then maintain the bypass power modules. After finishing the maintenance of the bypass power modules, insert the modules.
5. Transfer to normal mode as *section 6.3.2*.



The terminal of bypass power module is big, and it need more power when inserting bypass module to make sure tighten connection.

6.10 Language Selection

The LCD menus and data display are available in 4 languages: Simple Chinese, English, Korean, Traditional Chinese.

Perform the following procedure to select a language needed:



1. In main menu, press  to enter in function setting menu in the LCD screen.
2. Select language setting menu.
3. Select the language and make sure. At this time, all the words in the LCD will be displayed in the selected language.

6.11 Changing the Current Date and Time

To change system date and time:



1. In main menu, press  to enter in function setting menu in the LCD screen.
2. Select time setting
3. Enter new date and time, then enter to confirm it.

6.12 Control Password 1

The system is password protected to limit the operator's operating and control authorities. You can only operate and test the UPS and battery after entering correct password 1. The default password 1 is **12345678**.

Chapter 7 Operator Control and Display Panel

This chapter introduces the functions and operation instructions of the UPS operator control and display panel in detail, and provides LCD display information, including LCD display types, detailed menu information, prompt window information and UPS alarm list.

7.1 Introduction

The operator control and display panel is located on the front panel of the UPS. Through the LCD panel, the operator can operate and control the UPS, and check all measured parameters, UPS and battery status, event and history logs. The operator control panel is divided into three functional areas as shown in *fig.7-1*: mimic current path, LCD display & Menu, control and operation button. The detailed description of control and display panel is shown in *table.7-1*.

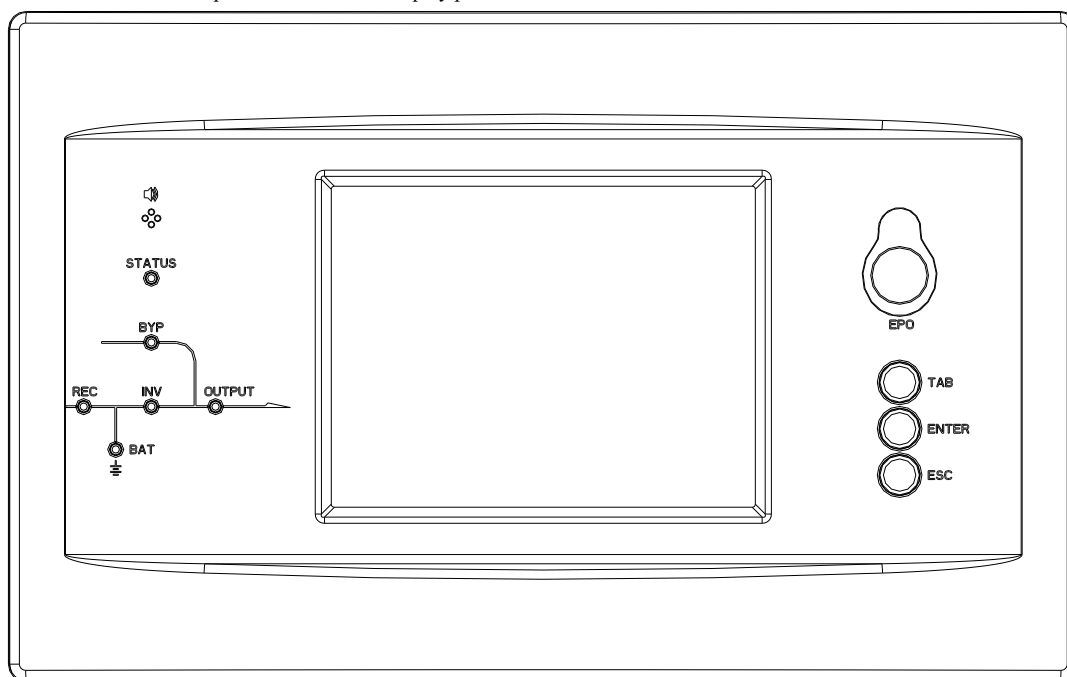

Fig.7- 1: UPS operator control and display panel

Table.7- 1: Description of UPS Operator Control and Display Panel

| Indicator | Function | Button | Function |
|-----------|---------------------|--------|---------------------------|
| REC | Rectifier indicator | EPO | EPO (emergency power off) |
| BAT | Battery indicator | TAB | Select |
| BYP | Bypass indicator | ENTER | Confirm |
| INV | Inverter indicator | ESC | Exit |
| OUTPUT | Load indicator | | |
| STATUS | Status indicator | | |

7.1.1 Mimic Current Path

The LEDs shown on the mimic current path represent the various UPS power paths and show the current UPS operating status. The status description of indicators is shown in *table.7-2*.

Table.7- 2: Status Description of Indicator

| Indicator | State | Description |
|---------------------|----------------|---|
| Rectifier indicator | Steady green | Rectifier of all modules is normal |
| | Flashing green | At least one of module rectifier is starting |
| | Steady red | At least one Rectifier of module fault |
| | Flashing red | Main input of at least one module is abnormal |
| | Off | Rectifier is not working |
| Battery indicator | Steady green | Battery is charging |
| | Flashing green | Battery is discharging |
| | Steady red | Battery is abnormal (battery failure, no battery or battery reverse) or battery converter is abnormal (failure, over current or over temperature) , EOD |
| | Flashing red | Battery voltage is low |
| | Off | Battery and battery converter is normal, battery is not charging |
| Bypass indicator | Steady green | UPS is working in bypass mode |
| | Steady red | Bypass is failure |
| | Flashing red | Bypass voltage is abnormal |
| | Off | Bypass is normal and is not working |
| Inverter indicator | Steady green | Inverter is feeding the load |
| | Flashing green | Inverter is starting, or UPS is working in ECO mode |
| | Steady red | At least one module's inverter is failure, and inverter is not feeding the load |
| | Flashing red | Inverter is feeding load, and at least one module's inverter is failure |
| | Off | Inverter is not working in all modules |
| Load indicator | Steady green | UPS output is on and is normal |
| | Steady red | UPS output is overload and time is over, or output is shorten, or output has no power supply |
| | Flashing red | UPS is overload |
| | Off | No output voltage |
| Status indicator | Steady green | Normal operation |
| | Steady red | Fault |

7.1.2 Audible Alarm (buzzer)

There are two different types of audible alarm during UPS operation as shown in *table.7-3*.

Table.7- 3: Description of Audible Alarm

| Alarm | Purpose |
|---------------------|---|
| Two short, one long | when system has general alarm (for example: main input abnormal), this audible alarm can be heard |
| Continuous alarm | When system has serious faults (for example: fuse or hardware fault), this audible alarm can be heard |

7.1.3 Functional Keys

There are 4 functional buttons on operator control and display panel, which are used together with LCD. The functions description is shown in *table.7-4*.

Table.7- 4: Functions of Functional Keys

| Functional key | Functions |
|----------------|--|
| EPO | To shutdown the rectifier, inverter, static bypass and battery |
| TAB | Select |
| ENTER | Confirm |
| ESC | Exit |

7.1.4 Battery Pack Indicator

The LED on the front panel of battery pack indicates battery pack status. If battery fuse in battery pack is broken, LED changes to be red. Customer must contact with our local distributor to maintain it.

7.2 LCD Display Type

Following the self-check of UPS LCD display, the main LCD display is shown as *fig.7-2*, which can be divided into three display windows: system information, data command and current record.

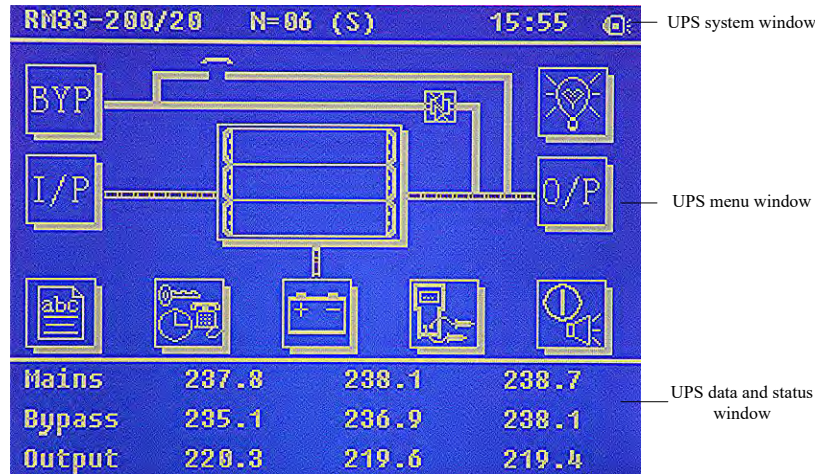









Fig.7- 2: Main LCD Display

The description of LCD icon is shown in *table.7-5*:

Table.7- 5: Description of LCD Icons

| Icon | Description |
|---|---|
|  | Bypass parameter(voltage, current, PF, frequency) |
|  | Main input parameter(voltage, current, PF, frequency) |
|  | History log, system information |
|  | Function setting (display calibration, password setting, time setting, date format, communication protocol and language setting), system setting (used only for manufacturer) |
|  | Battery data, battery parameter setting (used for service engineer) |
|  | Test (battery self-test, battery maintenance) |
|  | Functional keys used by service staff (fault clear, history log clear, mute on or off, manual transfer to bypass or escape from bypass), user setting (system mode, machine number, system ID, output voltage adjustment, frequency slew rate, frequency range) |
|  | Output parameter(voltage, current, PF, frequency) |

| Icon | Description |
|------|---|
| | Load(Apparent load, active load, reactive load, load percent) |
| | Mute off, mute on |
| | Page up/down |

The LCD menu tree is shown as below. Please refer to *table. 7-7: Item Description of UPS Menu*

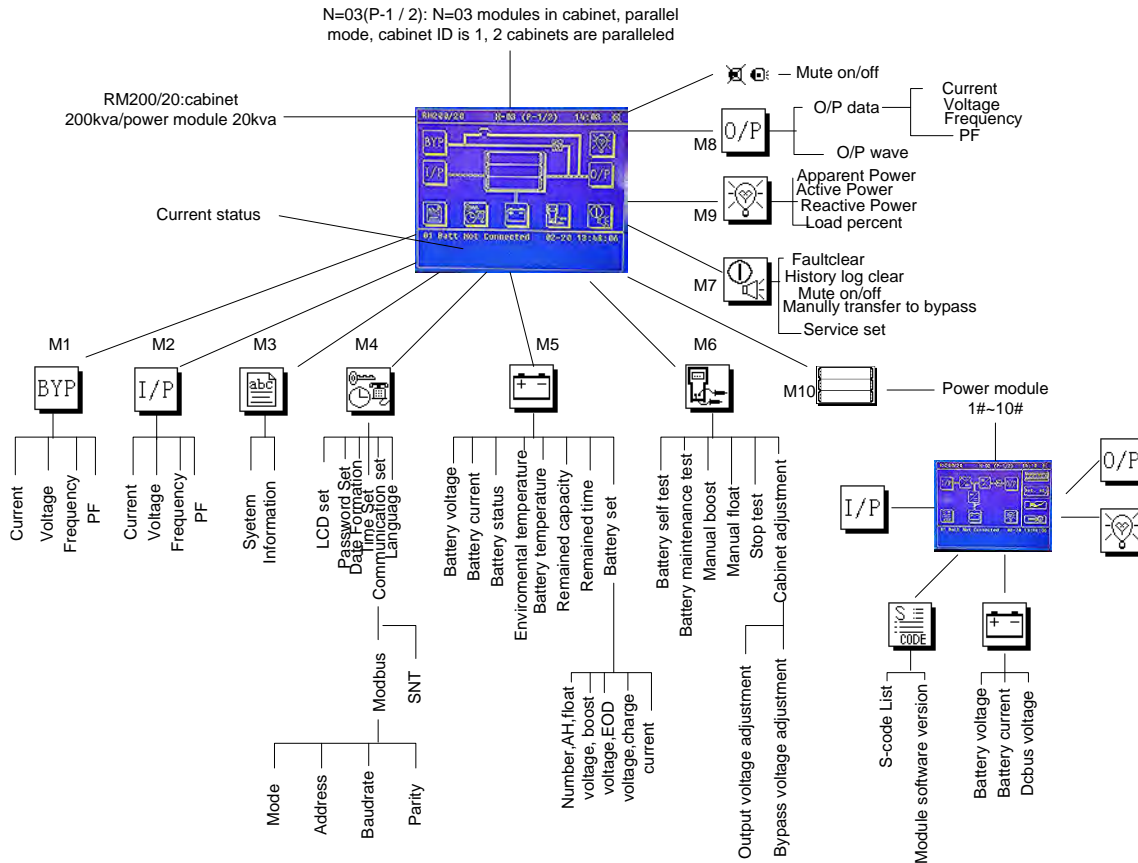

Fig.7- 3: Menu Tree Structure

7.3 Detailed Description of Menu Items

The LCD main display shown in *fig.7-3* is described in details below.

UPS information window

UPS information window: display the current time and UPS name. The information of the window is not necessary for the user to operate. The information of this window is given in *table.7-6*.

Table.7- 6: Description of Items in UPS System Information Window

| Display contents | Meaning |
|-------------------------------|--|
| RM200/20 | UPS model. 200-200KVA cabinet, 20-20KVA |
| N=03(P-1/2) | N=03-3 power modules in system. P-parallel mode, 2 units in parallel system, current unit is 1#. S-single mode. E-ECO mode. |
| 12:00 | Current Time (format: 24 hours, hour : minute) |
| (Status) Normal, alarm, fault | Normal: UPS in normal condition Alarm: UPS has general alarm, such as AC input fault Fault: UPS fuse or hardware fault |

UPS menu and data window

UPS menu window displays the menu name of data window, while the data window displays the related contents of selected menu in menu window. Select UPS menu and data window to browse related parameters of UPS and set related functions. The details are given in *table.7-7*.

Table.7- 7: Item Description of UPS Menu

| Menu name | Menu item | Meaning |
|------------------------|--------------------------|--|
| Main input | V phase(V) | Voltage |
| | I phase(A) | Current |
| | Freq.(Hz) | Frequency |
| | PF | Power factor |
| Bypass input | V phase(V) | Voltage |
| | Freq. (Hz) | Frequency |
| | I phase(A) | Current |
| | PF | Power factor |
| Output | V phase(V) | Voltage |
| | I phase(A) | Current |
| | Freq. (Hz) | Frequency |
| | PF | Power factor |
| This UPS module's load | Sout (kVA) | Apparent Power |
| | Pout (kW) | Active Power |
| | Qout (kVAR) | Reactive Power |
| | Load (%) | Load percent |
| Battery data | Environmental Temp | Environmental Temp |
| | Battery voltage(V) | Positive and negative battery voltage |
| | Battery current A) | Positive and negative battery current |
| | Battery Temp(°C) | Battery Temperature |
| | Remaining Time (Min.) | Remained battery backup time |
| | Battery capacity (%) | Remained battery capacity |
| | battery boost charging | Battery is working in boost charging mode |
| | battery float charging | Battery is working in float charging mode |
| | Battery disconnected | Battery is not connected |
| Current alarm | | Display all current alarm. The alarms are displayed on LCD |
| History log | | Display all history logs. |
| Function Settings | Display calibration | Adjust the accuracy of LCD display |
| | Date format set | MONTH-DATE-YEAR and YEAR-MONTH-DATE formats can be selected |
| | Date & Time | Date/Time set |
| | Language set | User can set the language |
| | Communication set | / |
| | Control password 1 set | User can modify control password 1 |
| Command | Battery maintenance test | This test will lead to the battery being partly discharged to activate battery until battery voltage is low. Bypass must be in normal condition, the battery capacity should be above 25%. |
| | Battery self-check test | UPS transfer to battery discharge mode to test if the battery is normal. Bypass must be in normal condition, the battery capacity should be above 25%. |

| Menu name | Menu item | Meaning |
|------------------------|-----------------------------|--|
| | Stop testing | Manually Stop the test including maintenance test, capacity test |
| UPS system information | Monitoring software version | Monitoring software version |
| | Rectified software version | Rectifier software version |
| | Inverted software version | Inverter software version |
| | Serial No. | The serial NO set when delivery from the factory |
| | Rated information | System rated information |
| | Module model | |

7.4 UPS Event Log

The follow *table.7-8* gives the complete list of all the UPS events displayed by history record window and current record window.

Table.7- 8: UPS Event List

| NO. | UPS events | Description |
|-----|--------------------|---|
| 1 | FaultClr | Manually clear fault |
| 2 | Log Clr | Manually clear History log |
| 3 | Load On UPS | Inverter feeds load |
| 4 | Load On Byp | Bypass feeds load |
| 5 | No Load | There is no output power for load. |
| 6 | Batt Boost | Charger is working in boost charging mode |
| 7 | Batt Float | Charger is working in float charging mode |
| 8 | Batt Discharge | Battery is discharging |
| 9 | Batt Connected | Battery is connected already |
| 10 | Batt Not Connected | Battery is not connected. |
| 11 | Maint CB Closed | Manual maintenance breaker is closed |
| 12 | Maint CB Open | Manual maintenance breaker is opened |
| 13 | EPO | Emergency Power Off |
| 14 | Inv On Less | Available power module capacity is less then the load capacity. Please reduce the load capacity or add extra power module to make sure that the UPS capacity is big enough. |
| 15 | Generator Input | Generator is connected and a signal is sent to the UPS. |
| 16 | Utility Abnormal | Utility (Grid) is abnormal. Mains voltage or frequency exceeds the upper or lower limit and results in rectifier shutdown. Check the input phase voltage of rectifier. |
| 17 | Byp Sequence Err | Bypass voltage Sequence is reverse. Check if input power cables are connected correctly. |
| 18 | Byp Volt Abnormal | <p>This alarm is triggered by an inverter software routine when the amplitude or frequency of bypass voltage exceeds the limit. The alarm will automatically reset if the bypass voltage becomes normal.</p> <p>First check if relevant alarm exists, such as “bypass circuit breaker open”, “Byp Sequence Err” and “Ip Neutral Lost”. If there is any relevant alarm, first clear this alarm.</p> <p>1. Then check and confirm if the bypass voltage and frequency displayed on the LCD are within the setting range. Note that the rated voltage and frequency are respectively specified by “Output Voltage” and “Output Frequency”.</p> <p>2. If the displayed voltage is abnormal, measure the actual bypass voltage and frequency. If the measurement is abnormal, check the external bypass power supply. If the alarm occurs frequently, use the configuration software to increase the bypass high limit set point according to the user’s suggestions</p> |
| 19 | Byp Module Fail | Bypass Module Fails. This fault is locked until power off. Or bypass fans fail. |

| | | |
|----|---------------------|--|
| 20 | Byp Ov Load | Bypass current is over the limitation. If bypass current is under 135% of the rated current. The UPS alarms but has no action. |
| 21 | Byp Ov Load Tout | The bypass overload status continues and the overload times out. |
| 22 | Byp Freq Ov Track | This alarm is triggered by an inverter software routine when the frequency of bypass voltage exceeds the limit. The alarm will automatically reset if the bypass voltage becomes normal. First check if relevant alarm exists, such as “bypass circuit breaker open”, “Byp Sequence Err” and “Ip Neutral Lost”. If there is any relevant alarm, first clear this alarm. 1. Then check and confirm if the bypass frequency displayed on the LCD are within the setting range. Note that the rated frequency are respectively specified by “Output Frequency”. 2. If the displayed voltage is abnormal, measure the actual bypass frequency. If the measurement is abnormal, check the external bypass power supply. If the alarm occurs frequently, use the configuration software to increase the bypass high limit set point according to the user’s suggestions |
| 23 | Exceed Tx Times Lmt | The load is on bypass because the output overload transfer and re-transfer is fixed to the set times during the current hour. The system can recover automatically and will transfer back to the inverter with 1 hour |
| 24 | Output Shorted | Output shorted Circuit. Fist check and confirm if loads have something wrong. Then check and confirm if there is something wrong with terminals, sockets or some other power distribution unit. If the fault is solved, press “Fault Clr” to restart UPS. |
| 25 | Batt EOD | Inverter turned off due to low battery voltage. Check the mains power failure status and recover the mains power in time |
| 26 | Batt Test OK | Battery Test OK |
| 27 | Batt Maint OK | Battery maintenance succeed |
| 28 | N# Comm Node Join | The N# Power Module is inserted in system. |
| 29 | N# Comm Node Exit | The N# Power Module is pulled out from system. |
| 30 | N# REC Fail | The N# Power Module Rectifier Fail, The rectifier has fault and results in rectifier shutdown and battery discharging. |
| 31 | N# INV Fail | The N# Power Module Inverter Fail. The inverter output voltage is abnormal and the load transfers to bypass. |
| 32 | N# REC OV Temp. | The N# Power Module Rectifier Over Temperature. The temperature of the rectifier IGBTs is too high to keep rectifier running. This alarm is triggered by the signal from the temperature monitoring device mounted in the rectifier IGBTs. The UPS recovers automatically after the over temperature signal disappears. If over temperature exists, check: 1. Whether the ambient temperature is too high. 2. Whether the ventilation channel is blocked. 3. Whether fan fault happens. 4. Whether the input voltage is too low. |
| 33 | N# Fan Fail | At least one fan fails in the N# power module. |
| 34 | N# Output Ov Load | The N# Power Module Output Over Load. This alarm appears when the load rises above 100% of nominal rating. The alarm automatically resets once the overload condition is removed. 1. Check which phase has overload through the load (%) displayed in LCD so as to confirm if this alarm is true. 2. If this alarm is true, measure the actual output current to confirm if the displayed value is correct. Disconnect non-critical load. In parallel system, this alarm will be triggered if the load is severely imbalanced. |
| 35 | N# INV Ov Load Tout | N# Power Module Inverter Over Load Timeout. The UPS overload status continues and the overload times out. |

| | | |
|----|---------------------|--|
| | | <p>Note:</p> <p>The highest loaded phase will indicate overload timing-out first.</p> <p>When the timer is active, then the alarm “unit over load” should also be active as the load is above nominal.</p> <p>When the time has expired, the inverter Switch is opened and the load transferred to bypass.</p> <p>If the load decreases to lower than 95%, after 2 minutes, the system will transfer back to inverter mode. Check the load (%) displayed in LCD so as to confirm if this alarm is true. If LCD displays that overload happens, then check the actual load and confirm if the UPS has over load before alarm happens.</p> |
| 36 | N# INV Ov Temp. | <p>The N# Power Module Inverter Over Temperature.</p> <p>The temperature of the inverter heat sink is too high to keep inverter running. This alarm is triggered by the signal from the temperature monitoring device mounted in the inverter IGBTs. The UPS recovers automatically after the over temperature signal disappears.</p> <p>If over temperature exists, check:</p> <ul style="list-style-type: none"> Whether the ambient temperature is too high. Whether the ventilation channel is blocked. Whether fan fault happens. Whether inverter overload time is out. |
| 37 | On Ups Inhibited | <p>Inhibit system transfer from bypass to UPS (inverter). Check:</p> <ul style="list-style-type: none"> Whether the power module’s capacity is big enough for load. Whether the rectifier is ready. Whether the bypass voltage is normal. |
| 38 | Manual Transfer Byp | Transfer to bypass manually |
| 39 | Esc Manual Byp | Escape from “transfer to bypass manually” command. If UPS has been transferred to bypass manually, this command enable UPS to transfer to inverter. |
| 40 | Batt Volt Low | Battery Voltage is Low. Before the end of discharging, battery voltage is low warning should occur. After this pre-warning, battery should have the capacity for 3 minutes discharging with full load. |
| 41 | Batt Reverse | Battery cables are connected not correctly. |
| 42 | N# INV Protect | <p>The N# Power Module Inverter Protect. Check:</p> <ul style="list-style-type: none"> Whether inverter voltage is abnormal Whether inverter voltage is much different from other modules, if yes, please adjust inverter voltage of the power module separately. |
| 43 | Ip Neutral Lost | The mains neutral wire is lost or not detected. For 3 phases UPS, it’s recommended that user use a 3-poles breaker or switch between input power and UPS. |
| 44 | Byp Fan Fail | At least one of bypass module Fans Fails |
| 45 | N# Manual Shutdown | The N# Power Module is manually shutdown. The power module shuts down rectifier and inverter, and there’s on inverter output. |
| 46 | ManBoost | Manually force the Charger work in boost charge mode. |
| 47 | Manfloat | Manually force the charger work in float charge mode. |
| 48 | Arrears Shutdown | Reserved. |
| 49 | Lost N+X Redundant | Lost N+X Redundant. There is no X redundant powers module in system. |
| 50 | EOD Sys Inhibited | System is inhibited to supply after the battery is EOD (end of discharging) |

Chapter 8 Optional Parts

8.1 Replacing Dust Filters

Each filter is held in place by a bracket on either side of each filter. To replace each filter:

1. Open the UPS front door and locate the filters on the back side of the front door (*see Fig. 8-1*).
2. Remove one bracket and loosen the screw on the second bracket. The second bracket need not be removed.
3. Remove the dust filter to be replaced.
4. Insert the clean filter.
5. Reinstall the bracket, tightening the screw securely.
6. Tighten the screw on the second bracket.

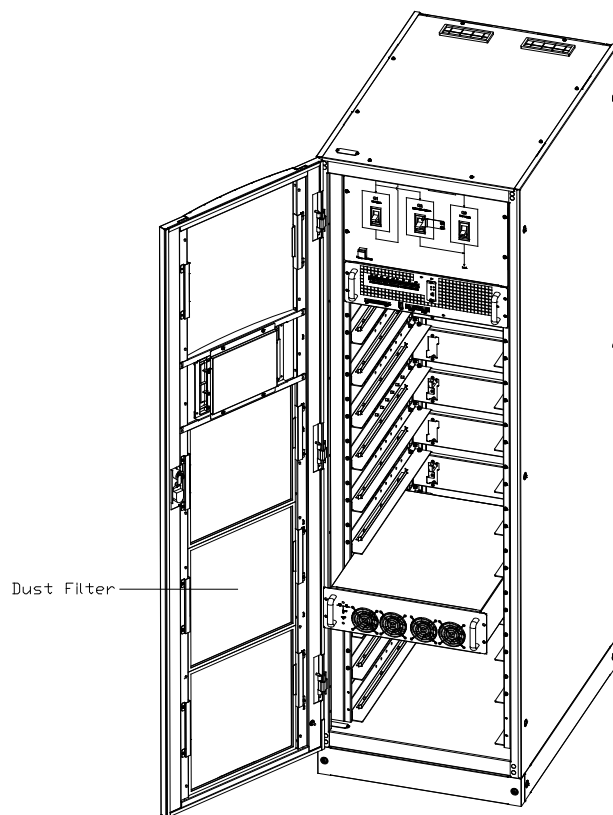

Fig.8- 1: Dust Filter

Chapter 9 Product Specification

This chapter provides UPS product specification.

9.1 Applicable Standards

The UPS has been designed to conform to the following European and international standards:

Table.9- 1: Compliance with European and International Standards

| Item | Normative reference |
|--|---|
| General safety requirements for UPS used in operator access areas | EN50091-1-1/IEC62040-1-1/AS 62040-1-1 |
| Electromagnetic compatibility (EMC) requirements for UPS | EN50091-2/IEC62040-2/AS 62040-2(C3) |
| Method of specifying the performance and test requirements of UPS | EN50091-3/IEC62040-3/AS 62040-3(VFI SS 111) |
| Note: The above mentioned product standards incorporate relevant compliance clauses with generic IEC and EN standards for safety (IEC/EN/AS60950), electromagnetic emission and immunity (IEC/EN/ AS61000 series) and construction (IEC/EN/AS60146 series and 60950). | |

9.2 Environmental Characteristics

Table.9- 2: Environmental Properties

| Items | Unit | Requirements |
|---|------|---|
| Acoustic noise level at 1 meter | dB | 58.0 |
| Altitude of Operation | m | ≤1000m above sea level, derate power by 1% per 100m between 1000m and 2000m |
| Relative Humidity | %RH | 0 to 95%, non condensing |
| Operating Temperature | °C | 0 to 40 deg , Battery life is halved for every 10°C increase above 20°C |
| UPS Storage-Transport Temperature | °C | -20~70 |
| Recommended Battery Storage Temperature | °C | 0~25 (20°C for optimum battery storage) |

9.3 Mechanical Characteristics

Table.9- 3: Mechanical Properties

| Cabinet Specification | Unit | 30/10,45/15, 60/20 | 60/10, 90/15, 120/20 | 100/10, 150/15, 200/20 | 60/20 battery built-in |
|------------------------------|------|---------------------------------------|----------------------|------------------------|------------------------|
| Mechanical Dimension, W×D×H | mm | 600×900×1100 | 600×900×1600 | 600×900×2000 | 600×1000×2000 |
| Weight | kg | 120 | 151 | 182 | --- |
| Color | N/A | Black | | | |
| Protection Level, IEC(60529) | N/A | IP20 | | | |
| Module type | Unit | 10 | 15 | 20 | |
| Mechanical Dimension, W×D×H | mm | 440×590×134 | | | |
| Weight | kg | 21 | 22.5 | 22.5 | |
| Color | N/A | Black(front), no colour (other sides) | | | |

9.4 Electrical Characteristics (Input Rectifier)

Table.9- 4: Rectifier AC Input (mains)

| Items | Unit | Parameter |
|-------|------|-----------|
|-------|------|-----------|

| | | |
|------------------------|-------------------|--|
| Rated AC Input Voltage | Vac | 380/400/415(three-phase and sharing neutral with the bypass input) |
| Input voltage range | Vac | -40%~+25% |
| Frequency ¹ | Hz | 50/60(range: 40Hz~70Hz) |
| Power factor | kW/kVA, full load | 0.99 |
| THD | THDI% | 3 |

9.5 Electrical Characteristics (Intermediate DC Link)

Table.9- 5: Battery Information

| Items | Unit | Parameters |
|-----------------------------|---------------|--|
| Battery bus voltage | Vdc | Nominal: $\pm 240V$, one-side range: 198V~288V |
| Quantity of lead-acid cells | Nominal | 480V=40*6cell(12V) |
| Float charge voltage | V/cell (VRLA) | 2.25V/cell(selectable from 2.2V/cell~2.35V/cell) Constant current and constant voltage charge mode |
| Temperature compensation | mV/°C /cl | -3.0(selectable from : 0~-5.0, 25°C or 30°C, or inhibit) |
| Ripple voltage | %V float | ≤ 1 |
| Ripple current | %C10 | ≤ 5 |
| Boost charge voltage | V/cell (VRLA) | 2.4V/cell(selectable from : 2.30V/cell~2.45V/cell) Constant current and constant voltage charge mode |
| End of discharging voltage | V/cell (VRLA) | 1.65V/cell(selectable from : 1.60V/cell~1.750V/cell) @0.6C discharge current 1.75V/cell (selectable from : 1.65V/cell~1.8V/cell) @0.15C discharge current (EOD voltage changes linearly within the set range according to discharge current) |
| Battery Charging Power | kW | 10%* UPS capacity (selectable from : 1~20%* UPS capacity) |

9.6 Electrical Characteristics (Inverter Output)

Table.9- 6: Inverter Output (to Critical Load)

| Rated capacity (kVA) | Unit | 10~200 |
|---|--------|---|
| Rated AC voltage ¹ | Vac | 380/400/415(three-phase four-wire and sharing neutral with the bypass) |
| Frequency ² | Hz | 50/60 |
| overload | % | 110% load, 1 hour 125% load, 10min 150% load, 1min >150% load, 200ms |
| Fault current | % | 300% short current limitation for 200ms |
| Non linear load Capability ³ | % | 100% |
| Neutral current capability | % | 170% |
| Steady state voltage stability | % | ± 1 (balanced load) ± 1.5 (100% unbalance load) |
| Transient voltage response ⁴ | % | ± 5 |
| THD | % | <1.5(linear load) , <5(non linear load ³) |
| Synchronization Window | - | Rated frequency $\pm 2Hz$ (selectable: $\pm 1 \sim \pm 5Hz$) |
| Max change rate of synch frequency | Hz/s | 1: selectable: 0.1~5 |
| Inverter voltage range | %V(ac) | ± 5 |
| Note: | | |

| Rated capacity (kVA) | Unit | 10~200 |
|---|------|--------|
| 1. Factory setting is 380V. Commissioning engineers can set to 400V or 415V. 2. Factory setting is 50Hz. Commissioning engineers can set to 60Hz. 3. EN50091-3(1.4.58) crest ratio is 3: 1. 4. IEC62040-3/EN50091-3 including 0%~100%~0% load transient, the recovery time is half circle to within 5% of stable output voltage. | | |

9.7 Electrical Characteristics (Bypass Input)

Table.9- 7: Bypass Input

| Rated capacity(kVA) | Unit | 30 | 45 | 60 | 90 | 100 | 120 | 150 | 200 |
|---|------|---|---------|---------|----------|----------|----------|----------|----------|
| Rated AC Voltage | Vac | 380/400/415 three-phase four-wire, sharing neutral with the rectifier input and providing neutral reference for the output | | | | | | | |
| Rated current | A | 46@380V | 68@380V | 91@380V | 136@380V | 151@380V | 182@380V | 227@380V | 302@380V |
| | | 43@400V | 65@400V | 87@400V | 130@400V | 144@400V | 174@400V | 216@400V | 288@400V |
| | | 42@415V | 63@415V | 83@415V | 124@415V | 138@415V | 166@415V | 207@415V | 276@415V |
| Overload | % | 125% load, long term | | | | | | | |
| | | 130% load, 1 hour | | | | | | | |
| | | 150% load, 6min | | | | | | | |
| | | 1000% load, 100ms | | | | | | | |
| Superior protection bypass line | N/A | Thermal-magnetic breaker, the capacity is 125% of rated current output. IEC60947-2 curve C | | | | | | | |
| Current rating of neutral cable | A | 1.7×In | | | | | | | |
| Frequency | Hz | 50/60 | | | | | | | |
| Switch time (between bypass and inverter) | ms | Synchronized switch: ≤1ms | | | | | | | |
| Bypass voltage tolerance | % | Upper limit: +10,+15 or +20, default: +20 | | | | | | | |
| | Vac | Lower limit: -10, -20, -30 or -40, default:-20 (acceptable stable bypass voltage delay: 10s) | | | | | | | |
| Bypass frequency tolerance | % | ±2.5, ±5, ±10 or ±20, default: ±10 | | | | | | | |
| Synchronization-Window | Hz | Rated frequency±2Hz (selectable from ±0.5Hz~±5Hz) | | | | | | | |
| Note: | | | | | | | | | |
| 1. Factory setting is 400V. Commissioning engineers can set to 380V or 415V. | | | | | | | | | |
| 2. Commissioning engineers can set to 50Hz or 60Hz. For example, UPS is set to frequency inverter mode, and then bypass status will be neglected. | | | | | | | | | |

9.8 Efficiency

Table.9- 8: Efficiency, Air Exchange

| Rated Efficiency () | Unit | 10~200kVA |
|---|---------------------|---------------------------------------|
| Efficiency | | |
| Normal mode(dual conversion) | % | 95 |
| ECO mode | % | 98 |
| Battery discharging efficiency (DC/AC) (battery at nominal voltage 480Vdc and full-rated linear load) | | |
| battery mode | % | 95 |
| Maximum air exchange | m ³ /min | 6.04/power module, 4.53/bypass module |

Appendix A Guide for Ordering and Selection of UPS Rack System

The UPS module can be divided into equipment cabinet and power module. For the cabinet lectotype please refer to the description as following:

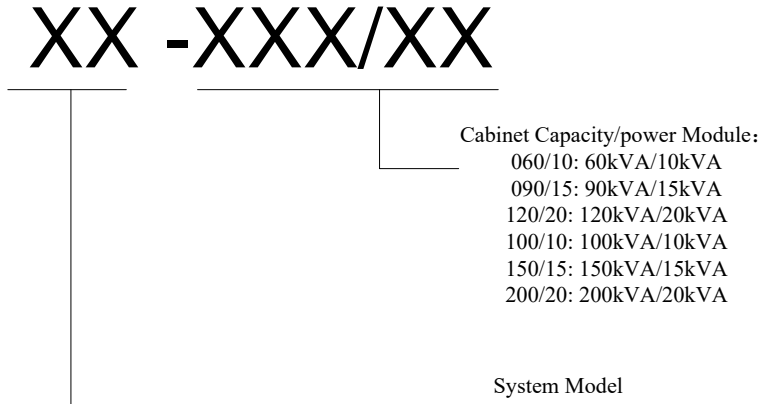

For single power module model please refers to the description as following:

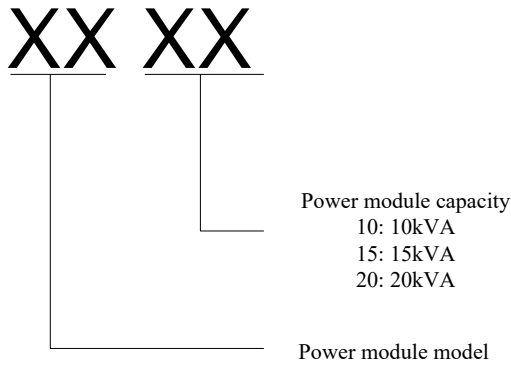

E.g.: the requirements of a plant room are given below:

The maximum power supply of the plant room is 120kVA; however, it is expected to be expanded to 200kVA in 3-5 years. Therefore, a 200kVA cabinet and 6 20kVA power module can be purchased to constitute an uninterrupted 120kVA power system which can be expanded to 200kVA on-line. The order symbol is:

- 1 set xx-200/20
- 6 set xx20

Option list:

- XX-SNMP card: remote network monitoring card
- XX-1100 dust filter: dust filter for 1.1m cabinet
- XX-1600 dust filter: dust filter for 1.6m cabinet
- XX-2000 dust filter: dust filter for 2m cabinet

Appendix B. Split-Bypass Input Connection

Fig.B-1 illustrates the modular UPS in what is known as the split-bypass configuration (that is, the bypass uses a separate AC source). In this configuration, the static bypass and maintenance bypass share the same independent bypass power supply and connect to the power supply through a separate switch. Where a separate power source is not available, the bypass and rectifier input supply connections are linked.



If split-bypass input is needed, please disconnect the linked copper bars, only phase A, B,C.
Split-bypass input is optional function.

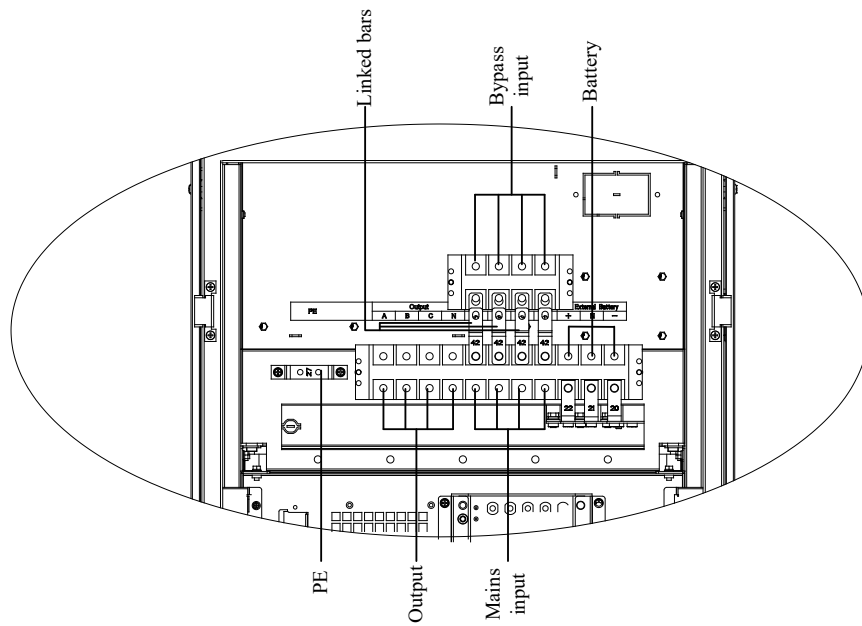

(a) Connection of Internal Battery Modular System

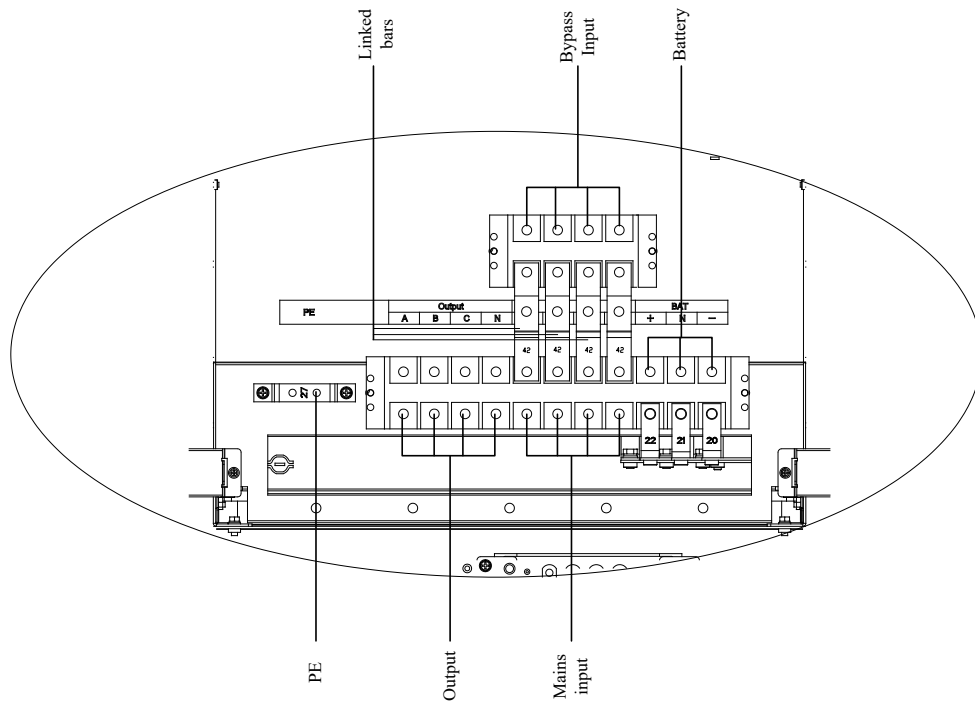

(b) Connection of 120KVA Modular System

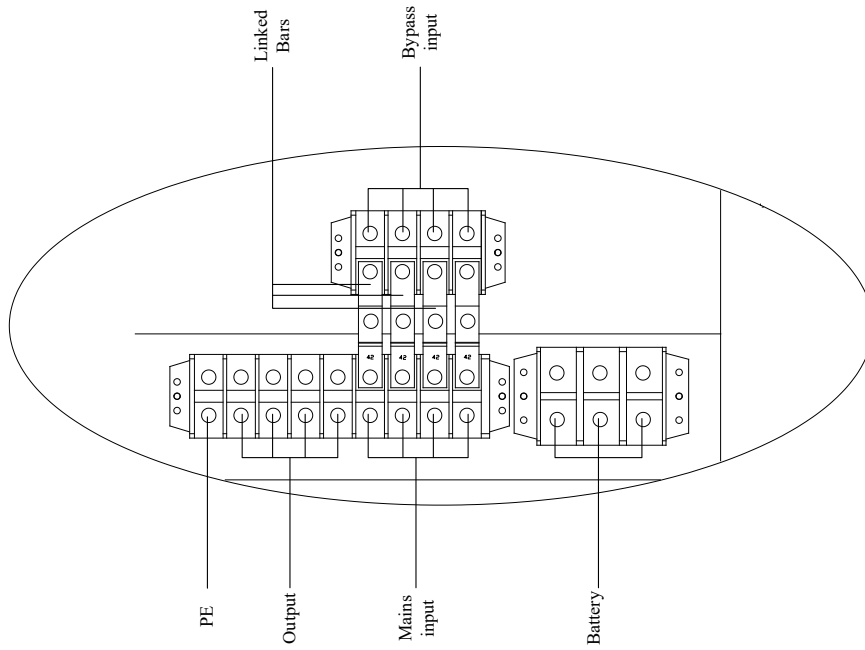

(c) Connection of 120KVA Modular System

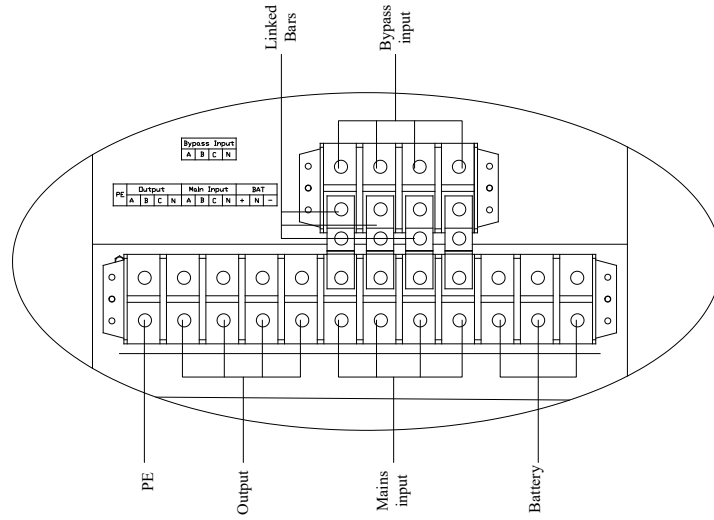

(d) Connection of 200KVA Modular System
Fig.B- 1: Split Bypass Connection of Modular System

AGKK14400 10/2021